

e-Notes of

**Communication Systems  
(4<sup>th</sup> semester ECE)**

By

**Sh. Rakesh Malik  
Lecturer, ECE Deptt. Govt.  
Polytechnic Jhajjar**

## CHAPTER-1 AM/FM TRANSMITTERS

### Learning Objectives:

After the completion of this chapter, the students will be able to:

- Classify the transmitters on the basis of modulation, service, frequency and power
- Demonstrate the working of each stage of AM and FM transmitters

### Classification of Radio Transmitters

*Classification on the basis of type of modulation used*

1. **Amplitude Modulation Transmitters:** Here the modulating signal modulates the carrier with respect to its amplitude. AM transmitters are used for radio broadcast, radio telephony, radio telegraphy and TV picture broadcast.
2. **Frequency Modulation Transmitters:** In FM transmitters, the frequency of the carrier is varied in accordance with the modulating signal. These are used for radio broadcast, TV sound broadcast and radio telephone communication.
3. **Pulse Modulation Transmitters:** The signal changes any of the characteristics like pulse width, position, amplitude of the pulse carrier.

*Classification on the basis of the service involved*

1. **Radio Broadcast transmitters:** These transmitters are particularly designed for broadcasting speech signals, music, information etc. These systems may be amplitude or frequency modulated.
2. **Radio Telephone Transmitters:** These transmitters are mainly used for transmitting telephone signals over long distance by radio waves. The transmitter uses volume compressors, peak limiters etc.
3. **Radio Telegraph Transmitters:** It transmits telegraph signals from one radio station to another radio station. The transmitter uses either amplitude modulation or frequency modulation.
4. **Television Transmitters:** TV broadcast requires transmitters for transmission of picture and sound separately. Both operate VHF and UHF frequency range.
5. **RADAR Transmitters:** RADAR stands for Radio Detection And Ranging. These transmitters are of two types: Pulse Radar and Continuous Wave Radar.
6. **Navigation Transmitters:** Special types of radio transmitters and receivers are used these days for sea and air navigation, blind landing of aircrafts etc.

*Classification on the basis of Frequency range used*

1. **Long Wave Transmitters:** These transmitters operate on frequencies below 300 kHz. Such long wave radio transmitters are used for broadcasting, where atmospheric disturbances on long waves are not severe.
2. **Medium Wave Transmitters:** The frequency range of MW transmitters is from 550 to 1650 kHz. The carrier power varies from 5 kW to 1000kW.
3. **Short Wave Transmitters:** The SW transmitters work on frequencies in the short wave range i.e. from 3 to 30MHz. For example, ionospheric propagation.

*Classification on the basis of power*

1. **High level modulation Transmitter:** In high level AM modulator, the modulation is carried out at high power level of the carrier and baseband signal. Its advantage is that linear amplifiers are not required for the RF amplification stages after AM modulation. The efficiency of high level modulation is very high due to the use of class C power amplifiers.
2. **Low level modulation Transmitter:** In low level AM modulator, the modulation is done at low power level of the input signals, typically in the RF generation stages. It

has the advantage of lesser distortion in output. The disadvantage of this method is that linear amplification is needed for the RF stages.

### Block diagram of AM transmitters

The transmitters which transmit AM signals are known as AM transmitters. These transmitters are used in medium wave and short wave frequency bands for AM broadcast. The MW band has frequencies between 550 KHz and 1650 KHz, and the SW band has frequencies ranging from 3 MHz to 30 MHz.

In high-level transmission, the powers of the carrier and modulating signals are amplified before applying them to the modulator stage as shown in below given figure.

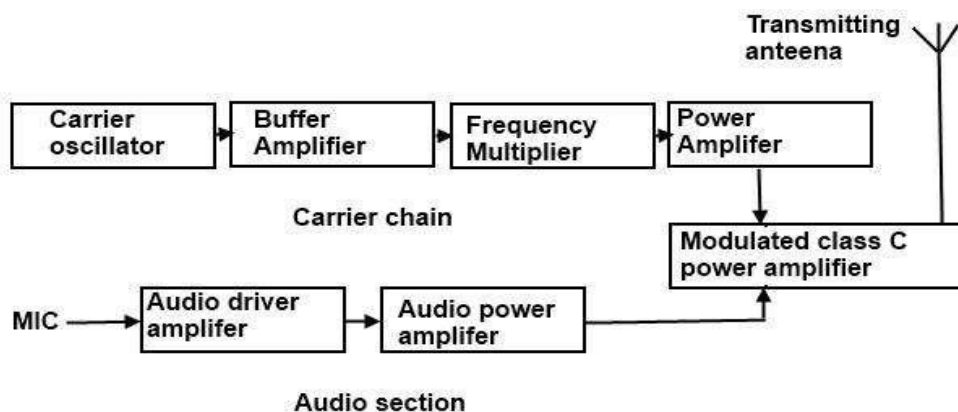

Figure (a) Block diagram of high level AM transmitter

**Carrier oscillator:** The oscillator generates the carrier signal of RF range. It is very difficult to generate high frequencies with good frequency stability. The oscillator generates only a sub multiple of the required carrier frequency. The frequency multiplier multiplies this sub multiple frequency to get the desired carrier frequency.

**Buffer Amplifier:** The purpose of the buffer amplifier is to match the output impedance of the carrier oscillator with the input impedance of the frequency multiplier. So, it isolates the carrier oscillator and frequency multiplier.

**Frequency Multiplier:** The sub-multiple frequency carrier signal, generated by the carrier oscillator, is applied to the frequency multiplier. The frequency multiplier (also called harmonic generator) generates higher harmonics of carrier oscillator frequency.

**Power Amplifier:** The power of the carrier signal is then amplified using the power amplifier stage. A class C power amplifier is used to give high power current pulses of the carrier signal at its output.

**Audio Section:** The audio signal obtained from the microphone is amplified using the audio driver amplifier. This amplification is necessary to drive the audio power amplifier. Then, a class A or B power amplifier amplifies the power of this audio signal.

**Modulated Class C Amplifier:** The amplified modulating audio signal and the carrier signal are applied to this modulating stage to carry out AM modulation. This signal is finally passed to the antenna, which radiates the signal into space.

In low-level modulation, the modulation is carried out at low power level of the two input signals. First modulation is done and after that the power of this modulated signal is raised to the desired value using linear power amplifiers. The low-level AM transmitter shown below is similar to a high-level transmitter, except that the powers of the carrier and audio signals are not amplified. These two signals are directly applied to the modulated class C power amplifier.

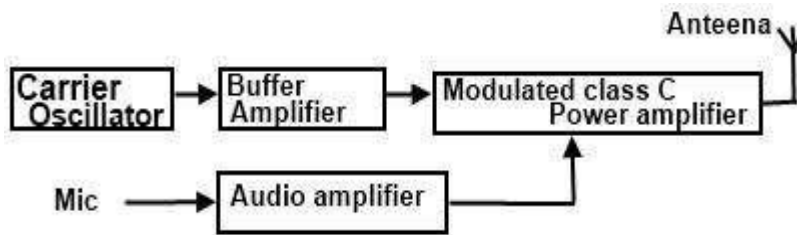

Figure (b) Block diagram of Low-level AM transmitter

### Reactance FET FM Transmitter

The reactance of FET and BJT, varactor diode etc. can be varied by the application of voltage. If it is placed across the tank circuit of the L-C oscillator, then FM will be produced when the reactance of the device is varied according to the modulating voltage. At the carrier frequency, the oscillator inductance is tuned by its own capacitance in parallel with the average reactance to the variable reactance device.

FET Reactance Modulator derivation:

- Neglecting gate current, let the current through C and R be  $I_1$ .
- At the carrier frequency, the reactance of C is much larger than R.

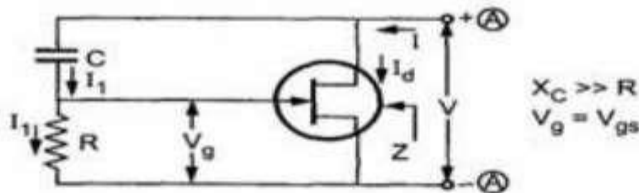

Then,

$$I_1 = \frac{V}{R + \frac{1}{j\omega C}}$$

$$\approx \frac{V}{\frac{1}{j\omega C}} = j\omega CV$$

$$V_g = I_1 R = j\omega CRV$$

$$I_d = g_m V_{gs} = g_m V_g$$

$$= j\omega CR g_m V$$

Then impedance of FET is,

$$Z = \frac{V}{I_d} = \frac{1}{j\omega [g_m CR]} = \frac{1}{j\omega [C_{eq}]}$$

Thus impedance is seen to be capacitive reactance with ,

$$C_{eq} = g_m CR.$$

- The operating point of FET i.e.  $g_m$  can be varied by modulating voltage and hence equivalent capacitance also changes.
- Since the equivalent capacitance depends upon  $g_m$ , which in turn, is dependent on bias voltage of FET,  $C_{eq}$  can be varied by varying bias voltage with modulating signal.
- By selecting values of R and C,  $C_{eq}$  can be initially adjusted to the desired value, in unmodulated conditions.
- If  $X_c/R$  is not much greater than unity, then equivalent impedance has resistive component, resulting in certain amplitude modulation.
- By interchanging R and C, and selecting the value of R such that R is  $\gg X_c$ ; then inductive reactance can be obtained.

### Armstrong FM Transmitter

The direct methods of FM generation cannot be used for the broadcast applications. Therefore the indirect method called as the Armstrong method of FM generation is used. In this method, the FM is generated through phase modulation. A crystal oscillator is used to make the frequency stability very high.

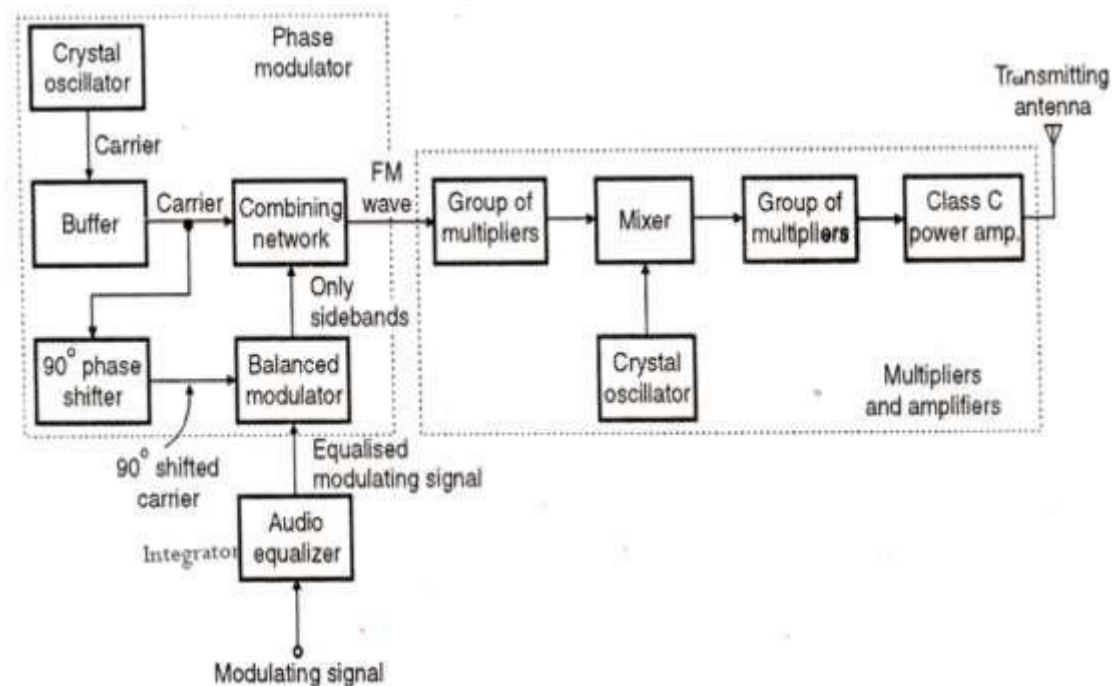

A crystal oscillator is used to provide the appropriate carrier frequency. A pre-emphasized, integrated and amplified modulating signal is fed to the balanced modulator stage. A part of the carrier voltage is also applied to the balanced modulator. The resulting sideband components are shifted in phase by  $90^\circ$  and are then combined with the amplified carrier voltage in a combining network. Its output is the desired frequency modulated voltage. The relative amplitudes of the modulating voltage and the carrier voltage are adjusted to make the maximum phase deviation small. But the frequency deviation  $f_d$  is also small. The modulated signal is fed to six frequency doublers to get very high carrier frequency, but frequency deviation is still small.

The FM signal is fed to a frequency mixer which shifts the carrier frequency down to a low value, so as to increase the frequency deviation. The frequency multipliers increase the carrier frequency and frequency deviation to a standard value. The output is applied to the transmitting antenna, after sufficient power amplification.

### Multiple Choice Questions

1. In a low level AM system, amplifiers following the modulated stage must be
  - (a) Linear devices
  - (b) Harmonic devices
  - (c) Class C amplifiers
  - (d) Non linear devices
  
2. Amplitude modulation is used for broadcasting because
  - (a) It is more noise immune than other modulation system
  - (b) Compared with other system it requires less transmitting power
  - (c) Its use avoids receiver complexity
  - (d) No other modulation system can provide the necessary bandwidth for high fidelity
  
3. Which one of the following is an indirect method of generating FM.
  - (a) Reactants FET modulator
  - (b) Varactor diode
  - (c) Armstrong modulator
  - (d) Reactance by polar transistor modulator.
  
4. Medium wave broadcast is used for
  - (a) Regional service
  - (b) National service
  - (c) International service
  - (d) All of above
  
5. Long wave AM broadcast transmitters need
  - (a) Small carrier power
  - (b) Medium carrier power
  - (c) Very large carrier power
  - (d) No need of carrier power
  
6. Long wave broadcast transmitter used in
  - (a) Tropical countries
  - (b) Temperate countries
  - (c) Everywhere
  - (d) Non of above

### **Short Answer Questions**

1. How will you classify transmitters on the basis of frequency?
2. Write the drawbacks of direct methods of FM generation.
3. What is the function of RF buffer amplifiers?
4. What do mean by short wave transmitters?
5. What is the bandwidth required by one television channel.
6. What is low level modulation?
7. What is high-level modulation?
8. Discuss advantages of Armstrong FM transmitter.

### **Long Questions**

1. Explain the working of Armstrong FM Transmitter.
2. With the help of block diagram, explain the working of High level AM transmitter.

## CHAPTER-2 AM/FM RADIO RECEIVERS

### Learning Objectives:

After completion of this chapter, the students will be able to

- Identify the waveforms at different stages of a Radio Receiver.
- Measure the performance characteristics of a radio receiver (sensitivity, selectivity, fidelity, S/N ratio, image rejection ratio).
- Determine the appropriate value of Intermediate Frequency.
- Identify the waveforms at different stages of a FM receiver.

### Super heterodyne AM receiver

A radio transmitter radiates a modulated carrier signal. It is intercepted by the antenna of a radio receiver. The signal is amplified and demodulated in the receiver section to produce original information signal. Super heterodyning involves mixing of frequency. Block diagram of the super heterodyne receiver is as explained below

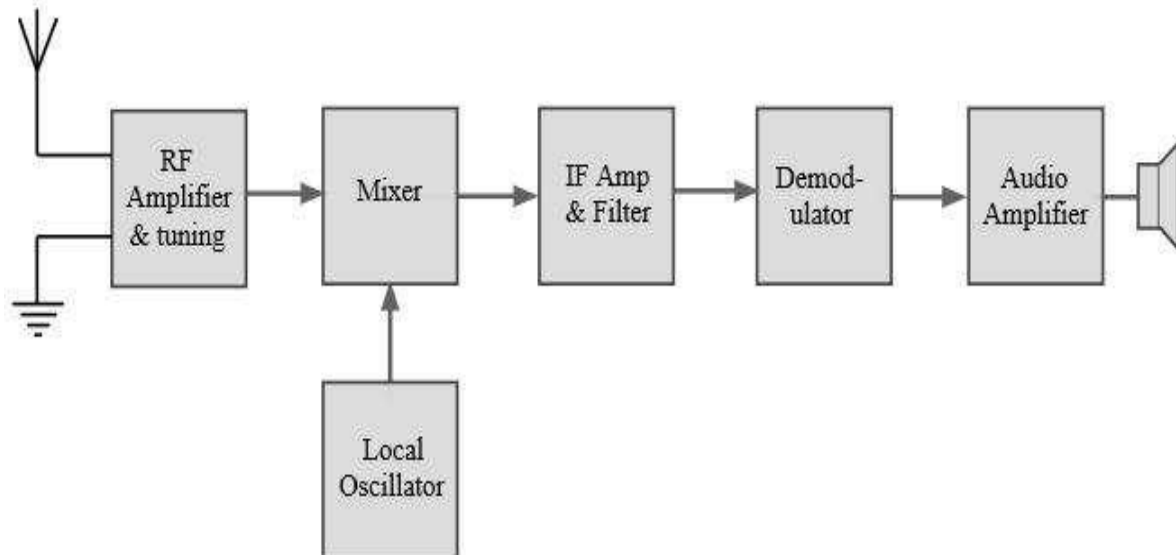



**RF Stage:** The RF stage of the receiver provides initial tuning to remove the undesired image signal. This RF amplifier block also raises the signal level so that the high noise immunity is achieved.

**Local oscillator:** Local oscillator frequency is generally higher than the incoming signal frequency by a value equal to intermediate frequency.

**Mixer:** Both the local oscillator and incoming signals enter this block within the super heterodyne receiver to form the intermediate frequency.

**IF amplifier & filter:** This super heterodyne receiver stage provides the majority of gain and selectivity. Crystal filters, LC or ceramic filters may be used within domestic radios.

**Demodulator:** The super heterodyne receiver block diagram only shows one demodulator, but in reality radios may have one or more demodulators dependent upon the type of signals being received.

**Audio amplifier:** Once demodulated, the recovered audio is amplified through audio amplifier stage to the required level for loudspeakers.

## Performance Characteristics of radio receiver

### Selectivity

The selectivity of a receiver is defined as its ability to accept or select the desired band of frequency and reject all other unwanted frequencies which can interfere with the original signals. Hence, the adjacent channel rejection of the receiver can be obtained from its selectivity parameter. Selectivity depends upon the response of IF section, mixer and RF section. The signal bandwidth must be narrow for better selectivity.

Selectivity can be represented by a curve shown in Fig1. , which shows the attenuation offered to the unwanted signals around the tuned frequency.

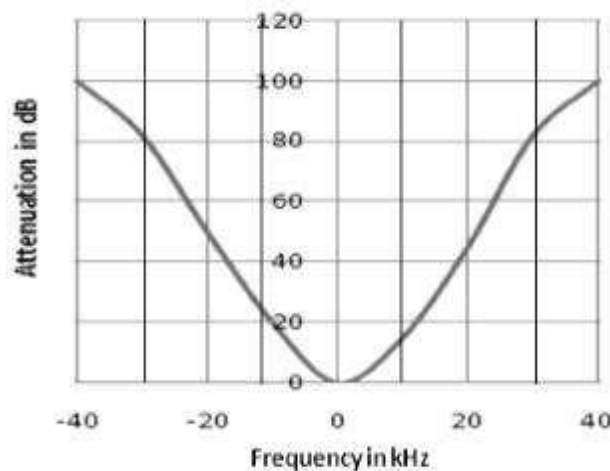

Fig1. Selectivity curve

### 2. 2.2 Fidelity

Fidelity of a receiver may be defined as its ability to reproduce the exact replica of the transmitted signals at the receiver output. The amplifier must pass high bandwidth signals to amplify the frequencies of the outermost sidebands for achieving better fidelity, while for better selectivity the signal should have narrow bandwidth. Thus, a tradeoff between selectivity and fidelity is necessary.

### Sensitivity

Sensitivity of the radio receiver is defined as its ability to amplify weak signals. It is defined in terms of voltage/power that must be applied to the input terminals of the receiver to produce a standard output power which is measured at the output terminals. The high value of receiver gain ensures smaller input signal necessary to

produce the desired output power. Thus a receiver with good sensitivity will detect minimum RF signal at the input and produce useful demodulated signal.

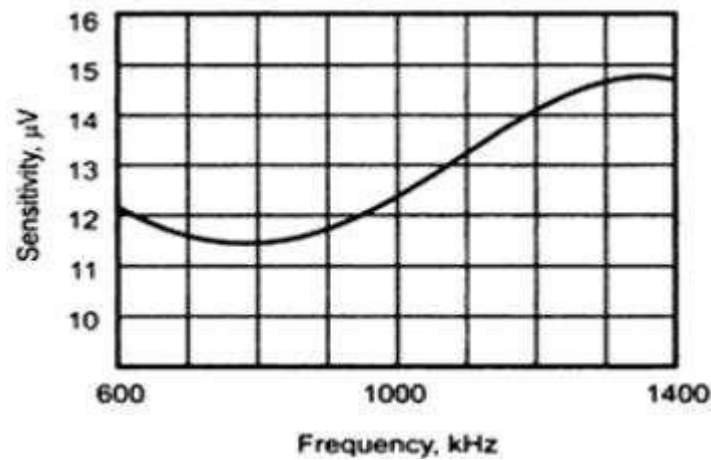

Fig 2. Sensitivity curve

Sensitivity is expressed in microvolts or decibels. It depends on the gain of IF amplifier. It can be enhanced by reducing the noise level and bandwidth of the receiver. Sensitivity can be represented as a curve shown in Fig 2 above, which shows the variation of sensitivity over the tuning band.

#### SNR

It is defined as the ratio of signal power to noise power at the same point in the circuit. It is used to measure radio receiver sensitivity. The lower the noise generated in the receiver, the better will be the SNR.

$$SNR = P_{\text{signal}} / P_{\text{noise}}$$

#### Image frequency ratio

Image frequency is termed as any frequency other than the selected radio frequency carrier that will produce a cross-product frequency that is equal to the intermediate frequency if allowed to enter a receiver and mix with the local oscillator.

The image frequency rejection ratio is defined as the ratio of the intermediate-frequency (IF) signal level produced by the desired input frequency to that produced by the image frequency. The image frequency rejection ratio is expressed in dB. Mathematically it is expressed as,

$$IFRR = \sqrt{1 + Q^2 \rho^2}$$

where  $\rho = (f_{im}/f_{RF}) - (f_{RF}/f_{im})$

Q = quality factor of a pre-selector

If an image frequency has down-converted to IF, it cannot be removed. In order to reject the image frequency, it has to be blocked prior to the mixer stage. So the bandwidth of the pre-selector circuit must be sufficiently narrow to restrain image frequency from entering the receiver.

## Selection of Intermediate Frequency

The value of IF depends upon following criteria:

- The choice of IF is affected by the selectivity of the RF end of the receiver. If the receiver has a number of RF stages, it is better able to reject an image signal close to the signal frequency and hence a lower IF channel can be tolerated.
- The chosen IF frequency should be free from radio interference. 455 KHz is a common IF for AM broadcast.
- High IF results in poor selectivity and therefore poor rejection of adjacent channels. High IF results in problems in tracking of signals in the receivers. Image frequency rejection becomes poor at low and very high IF.

## Simple & Delayed AGC

Automatic gain control (AGC) is a process where the overall gain of the radio receiver is automatically varied according to the changing strength of the received input signal. This is carried out to maintain the output at a constant level. The AGC dc bias voltage is derived from the part of the detected signal to apply to the RF, IF and mixer stages to control their gains. The Trans conductance and hence the gain of the devices used in these stages of the receiver depends on the applied bias voltage or current. When the signal level increases, the value of the applied AGC bias increases, decreasing the gain of the connected stages. When there is no/low signal, the AGC bias becomes minimum which results in maximum amplifier gain.

There are two types of AGC circuits:

**Simple AGC:** The gain control mechanism is active for high as well as low value of carrier voltage.

**Delayed AGC:** AGC bias is not applied to the amplifiers until signal strength crosses a predetermined threshold level, after which AGC bias is applied.

## FM RECEIVER

An FM receiver is a super heterodyne receiver with the following block diagram:

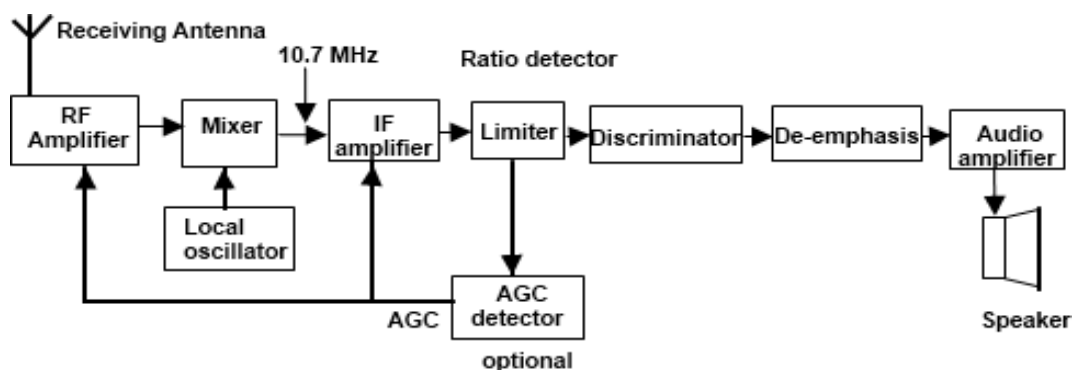

Superheterodyne FM Receiver Block Diagram

**RF section:** It consists of a pre-selector and an amplifier. Pre-selector circuit is a widely-tuned band pass filter with an adjustable center frequency used to reject undesired radio frequency and to decrease the noise bandwidth. RF amplifier determines the sensitivity of the receiver.

**Mixer and local oscillator:** It consists of a radio-frequency oscillator and a mixer. The choice of oscillator depends on the stability and accuracy desired. Mixer is a nonlinear

device used to translate radio frequency to intermediate frequencies (i.e. heterodyning process).

**IF section:** It consists of a series of IF amplifiers and band pass filters to achieve most of the receiver gain and selectivity. The IF value is always lower than the RF because it is easier and less expensive to construct high-gain, stable amplifiers for low frequency signals.

**Limiter:** It limits the IF signal to a particular level and keep the amplitude constant after removing amplitude variations.

**Discriminator:** It converts the IF signals back to the original source information (demodulation).It can be as simple as a single diode or as complex as a PLL or balanced demodulator.

**De-emphasis network:** It is used to bring the high frequency signals back to the proper amplitude relationship with the lower frequencies.

**Audio amplifier:** Comprises several cascaded audio amplifiers

**AGC (Automatic Gain Control):** It operates to adjust the IF amplifier gain according to signal level. AGC is a process by which the overall gain of radio receiver is varied automatically with the variations in the received signals strength, to maintain the output constant. AGC circuit is also used to adjust and stabilize the frequency of local oscillator.

## Communication receiver

The receiving antenna intercepts the electromagnetic radiations and converts them into RF voltage. The RF signal is then applied to the RF amplifier through the antenna coupling network, which matches the impedances of the antenna and the RF amplifier. The RF stage amplifies this signal, which lies in the frequency range of 2 - 30 MHz. The amplified signal is fed to the first mixer, in order to be mixed with the locally generated signal. The frequency of the local oscillator is 650 kHz above the frequency the receiver signal. The first local oscillator and the RF amplifier are ganged together to generate the correct oscillator frequency.

The mixer stage generates an IF signal at frequency of 650 kHz. The IF signal is amplified by the first IF amplifier. After this, the IF signal is fed to the second mixer, which mixes this signal with another locally generated signal. The second local oscillator frequency is fixed at 500 kHz. Therefore, a crystal oscillator is used here to have good frequency stability.

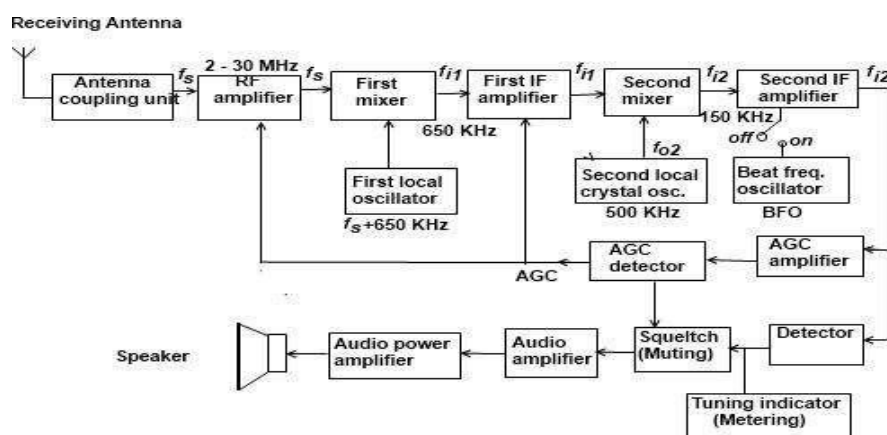

The second mixer generates the second IF signal. Value of the second IF is 150 kHz (difference between first IF (650 kHz) and second local oscillator frequency (500 kHz)). The second IF frequency is put below the normal IF frequency (455 KHz) of the AM receiver. The first IF signal frequency is above 455 kHz, up to a value of 650 kHz. Due to this arrangement, the communication receiver has the benefits of both low and high IF frequency. This mechanism of using two frequencies is known as double conversion. The second IF signal is amplified using the IF amplifier stages again to the required value.

After this, the detector circuit demodulates the received signal to produce an audio signal. This audio signal is then amplified by the audio driver amplifier and the audio output power amplifier. The audio signal is given to the speaker to produce the sound output. AGC is employed to control the gains of the amplifiers of the system. The AGC voltage helps to keep the volume of the receiver constant to the level set by the user. The salient features of the communication receiver are:

**Beat Frequency Oscillator (BFO):** Communication receivers can also receive telegraphic signals that use Morse code, which is a pulse modulated RF carrier signal. Morse code is transmitted as dots, dashes, and spaces. A switch is used in the receiver to select either the audio signal or the telegraph signal at a time.

**Squelch or Muting:** When the communication transmitter does not transmit any signal, the receiver receives only the noise present at its input. It is necessary to control the noise level in the absence of a carrier signal. This problem is overcome by providing a Squelch circuit in the system.

**Metering:** A tuning indicator is provided in the receiver so that the operator knows if the receiver is tuned to the correct signal frequency. It is called metering of the strength of the received signal.

**Double Conversion:** In the double conversion method, two intermediate frequencies are generated instead of a single intermediate frequency used in commercial AM receivers. This technique uses two local oscillators and two mixers.

### Multiple Choice Questions

1. A receiver has poor IF selectivity. It will, therefore, also have poor
  - a) blocking
  - b) double spotting
  - c) diversity reception
  - d) sensitivity
2. In a radio receiver with a simple AGC ;
  - a) an increase in signal strength produces more AGC .
  - b) the audio stage gain is normally controlled by the AGC .
  - c) the faster the AGC time constant, the more accurate the output.
  - d) the highest AGC voltage is produced between stations.
3. In a radio detector
  - a) Stabilization against signal strength variation is provided
  - b) The linearity is worse than in a phase discriminator
  - c) the output is twice that obtainable from a similar phase discriminator
  - d) the circuit is same as in a discriminator except that the diodes are reversed .
4. The intermediate frequency is very high,
  - a) image frequency rejection is very good .
  - b) the local oscillator need not be extremely stable .
  - c) the selectivity will be poor .
  - d) tracking will be improved
5. When a receiver has a good blocking performance, this means that
  - a) it suffers from double spotting.
  - b) Its image frequency rejection is poor.
  - c) It is unaffected by AGC derived from nearby transmissions
  - d) Its detector suffers from burnout

### **Short Answer Questions**

1. Write the functions of an RF amplifier stage
2. Define fidelity.
3. What do you mean by selectivity?
4. Define pre-emphasis and de-emphasis.
5. What is the function of a limiter?
6. Explain the term detection of signal.
7. Explain the various applications of super heterodyne receivers.
8. Explain the term sensitivity of receiver.

### **Long Answer Questions**

1. Explain the working of super heterodyne receiver.
2. Explain the concept of simple AGC and delayed AGC.
3. Explain in detail the working of FM receivers with the help of block diagram.

## CHAPTER-3 ANTENNAS

### Learning Objectives:

After completion of this chapter, the students will be able to

- Identify the various types of antennas used in different frequency ranges.
- Plot the radiation pattern of directional and omni-directional antenna.
- Plot the variation of field strength of a radiated wave, with distance from a transmitting antenna.

### Introduction

Antenna is a system which transforms the output RF energy produced by radio transmitter into an electromagnetic field which is radiated through space. It is an interface between receiver circuit and space.

### EM spectrum

The range of frequencies of electromagnetic radiation and their respective wavelengths are arranged to form an Electromagnetic Spectrum, as shown in the figure below.

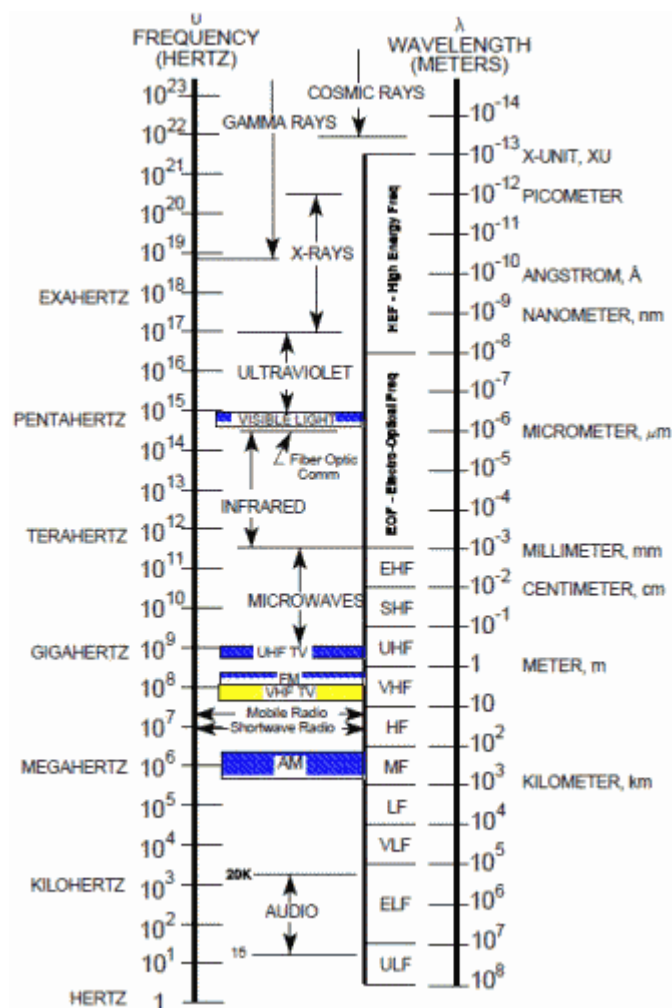

### Polarization of waves

Polarization is the technique of the orientation of the lines of electric field in an electromagnetic field. The physical orientation of an antenna corresponds to the polarization of the radio waves received or transmitted by that antenna. Thus, a vertical antenna radiates and receives vertically polarized waves, and a horizontal antenna radiates and receives horizontally polarized waves.

If the polarization rotates 360 degrees with each complete wave cycle, then this type of polarization is called elliptical or circular polarization, can be either clockwise or counter clockwise. The best communications results are obtained when the transmitting and receiving antennas have the same sense of polarization (both clockwise or both counter clockwise). The worst communications usually take place when the two antennas radiate and receive in the opposite sense (one clockwise and the other counter clockwise).

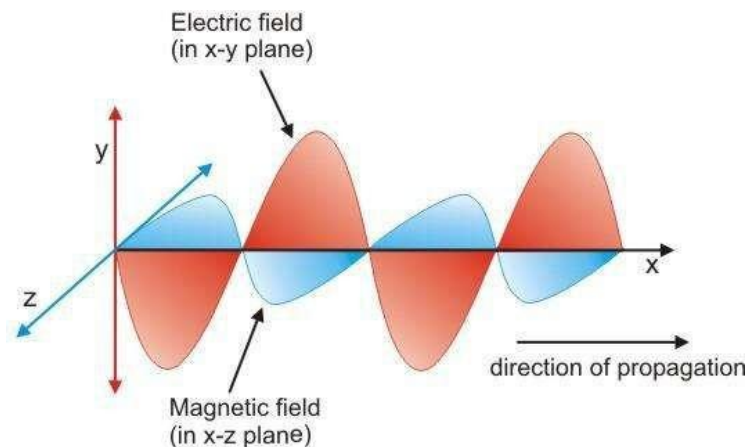

Polarization has an effect upon the propagation of EM fields at infrared (IR), visible, ultraviolet (UV) and X-ray wavelengths. In visible light, there are various wave components at random polarization angles. When this light is passed through a special filter, the filter blocks all light except that having a certain polarization. When two such polarizing filters are placed in such a manner that a ray of light passes through them, the amount of light transmitted depends on the angle of the polarizing filters with respect to each other. The most of the light is transmitted when the two filters are oriented, so they polarize light in the same direction. The minimum light is transmitted when the filters are oriented at right angles to each other.

### **Antenna Parameters**

#### *Point source*

Point sources are the radio wave sources which are smaller than one radio wavelength in size. Electromagnetic radiations generated by a fixed electrical circuit are normally polarized, producing anisotropic radiation. When the propagating medium is lossless, the radiated power at a given distance will vary as the inverse square of the distance, if the angle remains constant to the source polarization.

#### *Directive gain or directivity*

It is the ratio of radiation intensity in the given direction to the radiation intensity of a reference antenna. The maximum directive gain is known as directivity.

#### *Power gain*

Power gain is a unitless measure that combines an antenna's efficiency and directivity  $D$ .

$$G = \epsilon_{\text{antenna}} \cdot D$$

#### *Aperture/effective area*

Antenna aperture is a measure of how effective an antenna is receiving the power of electromagnetic radiation. The aperture is represented as the area, oriented perpendicular to the direction of an incoming electromagnetic wave, which would intercept the same amount of power from that wave as is produced by the antenna receiving it.



$$A_e = \frac{\lambda^2}{4\pi} G = \frac{c^2}{f^2} \times \frac{G}{4\pi}$$

### *Radiation Pattern*

Radiation pattern of the antenna gives the pictorial view of the energy radiated by it. Radiation pattern is diagrammatical representation of the distribution of radiated energy into space, as a function of direction. The power distribution is plotted as a function of square of the magnitude of electric and magnetic fields. The patterns are plotted on logarithmic or dB scale.

### *Beam width*

In an antenna radiation pattern, the half power beam width is the angle between the half-power (-3 dB) points of the main lobe, when referenced to the peak effective radiated power of the main lobe.

### *Radiation and loss resistance*

It is that part of an antenna's feed point resistance that is caused by the radiation of electromagnetic waves from the antenna, as opposed to loss resistance (also called ohmic resistance) which usually causes the antenna to heat up. The sum of radiation resistance and loss resistance is the electrical resistance of the antenna. The radiation resistance is calculated from the geometry of the antenna, whereas the loss resistance is generally determined by the materials it is made of. The energy lost by ohmic resistance is converted to heat and the energy lost by radiation resistance is converted to electromagnetic radiation. Radiation resistance is affected by the radiation reaction of the conduction electrons in the antenna.

### **Half wave dipole**

The half wave dipole is formed from a conducting wire or metal tube which is an electrical half wavelength long. It is normally fed in the middle where the impedance decreases to its lowest. The length of the half wave dipole is an half of the electrical wavelength for the wave travelling in the antenna conductors.

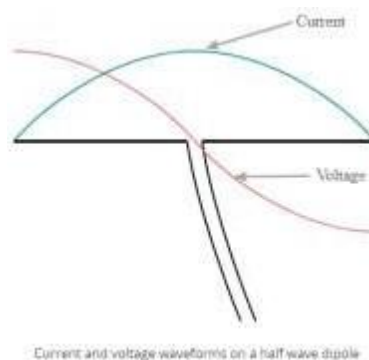

The voltage and current amplitude vary along the length of the radiating section of the antenna. This happens because standing waves are set up along the length of the radiating element. The current at end points is zero, but the voltage is at its maximum. The current reaches a maximum and the voltage a minimum at a length equal to an electrical quarter wavelength from the ends as shown in figure. The feeder is connected to the centre point where there is a current maximum and a voltage minimum. This results in the antenna presenting low impedance to the feeder. The impedance for a half wave dipole antenna in free space is dipole  $73 \Omega$  which presents a good match to  $70 \Omega$  coaxial feeder.

The radiation pattern of the half-wave dipole is omni-directional. It is used for many applications such as mobile communications, radio receivers etc.

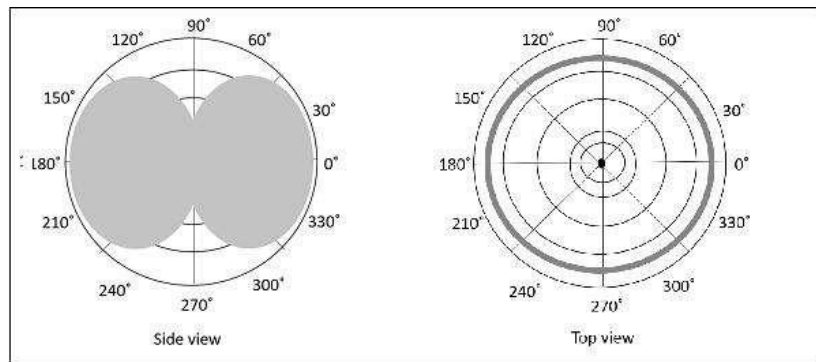

**Advantages:** Input impedance is not sensitive.  
Length of the antenna matches with size and directivity.

**Disadvantages:** Not much effective due to single element. It can work better only with a combination.

**Applications:** Used in radio receivers, television receivers, antenna arrays etc.

### Medium wave antenna

The MW or mast antennas have been developed in order to cover mobile systems needs as well as the emergency service of temporary MW AM broadcasting. They can also be employed as stationary antennas for services in the MW broadcasting range. The antenna system comprises of antenna, matching unit and a coaxial feeder line. This antenna system consists of a grounded vertical tower with six folded wires spaced in 60 degrees around the tower.



Medium wave antennas are placed vertically closed to the ground, radiating vertically polarized signals. Their height is between one-fourth to five-eighth of the wavelength. Three ways of feeding the mast antennas are: base feed, shunt feed and multiple feed.

### Folded dipole antenna

The folded dipole antenna comprises a basic dipole with an added conductor connecting the two ends together to make a complete loop of wire. The antenna is called a folded dipole due to its folded ends. The first element of the folded dipole is fed directly while the second is coupled inductively. The radiation pattern of folded dipole is same as of a simple dipole with increased input impedance.

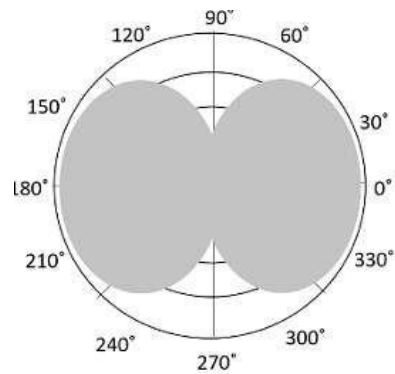
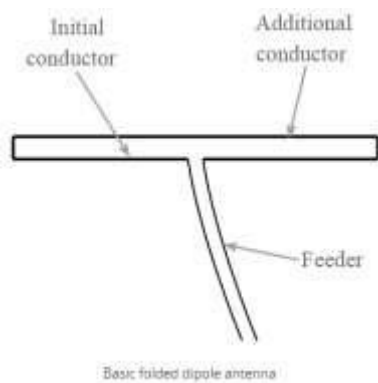

The power supplied to a folded dipole antenna is evenly divided between the two sections of the antenna. So, when compared to a standard dipole the current in each conductor is reduced to a half. As the same power is applied, the impedance has to be raised by a factor of four, so that  $P = I^2 \times R$ . The half wave folded dipole operates in the frequency range from 3KHz to 300GHz. The folded dipole antenna has the advantage of having high impedance and wide bandwidth. The limitations of the antenna are difficult installment and large size. It is used as a feeder element in Yagi antenna, Parabolic antenna, turnstile antenna, log periodic antenna etc.

### Loop antenna

A loop antenna is a radio antenna consisting of a loop or coil of wire which can have the shape of a circle, rectangle, square etc. Its dimensions are much smaller than a wavelength. The loop is always surrounded by a perpendicular magnetic field. The radiation pattern is independent of its shape and is generally of doughnut shape given below. These are used on frequencies between 3–30 MHz for both transmission and reception.

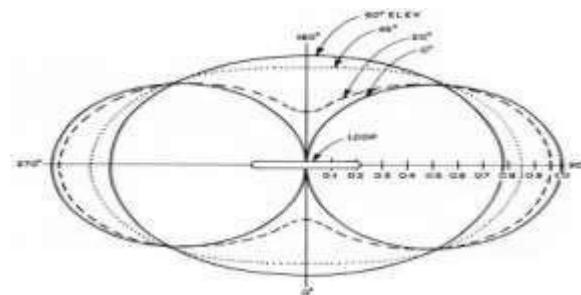

They are used in RFID devices, MF, HF and Short wave receivers, Aircraft receivers for direction finding. The advantages of Loop antenna are its compact size and high directivity. The disadvantages of Loop antenna are poor impedance matching and low radiation efficiency.

### Yagi-Uda Antenna

Yagi-Uda antenna is named after the inventors Prof. S.Uda and Prof. H.Yagi. The basic element used in this antenna is half wave dipole placed horizontally called as driven element or active element. In order to convert bidirectional dipole into unidirectional system, the passive elements are used which include reflector and director. The passive or parasitic elements are placed parallel to driven element placed close together as shown in figure. The length of director is 5% less than the driven element. The length of reflector is 5% more than that of driven element. The space between the elements varies between  $0.1\lambda$  to  $0.3\lambda$ . For a

three element system, Reflector length =  $500/f$  (MHz) feet, Driven element length =  $475/f$  (MHz) feet and Director length =  $455/f$  (MHz) feet.

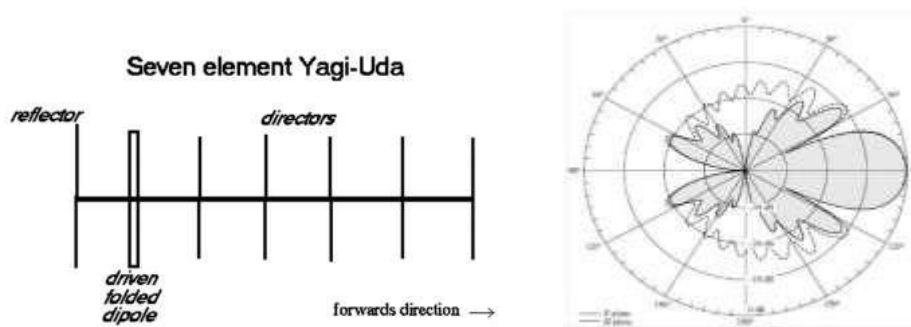

It radiates in only one direction and is most commonly used in point-to-point communications. The Yagi-Uda antenna is used in a wide variety of applications where an RF antenna design with high gain and directivity is required such as television reception. It has disadvantage of complexity and large size.

A Yagi system has the following characteristics:

- The three element array is generally referred as “beam antenna”
- It has unidirectional pattern of moderate directivity with light weight, low cost and simplicity in design.
- The bandwidth increases between 2% when the space between elements ranges between  $0.1\lambda$  to  $0.15\lambda$ .
- It gives a gain of 8 dB and a front-to-back ratio of 20dB.
- Yagi is also known as super-directive or super gain antenna because of its high gain.
- For achieving greater directivity, more directors are used. Arrays can be stacked to increase the directivity.
- Yagi is essentially a fixed frequency device. Frequency sensitivity and bandwidth of about 3% is achievable.

### Ferrite Rod Antenna

The ferrite rod antenna is a form of RF antenna design that is used in portable transistor broadcast receivers as well as many hi-fi tuners for reception on the long, medium and short waves. The antenna consists of a rod made of highly permeable ferrite material. A coil is wound around the ferrite rod and this is brought to resonance using a variable tuning capacitor. Its radiation pattern is as given below.

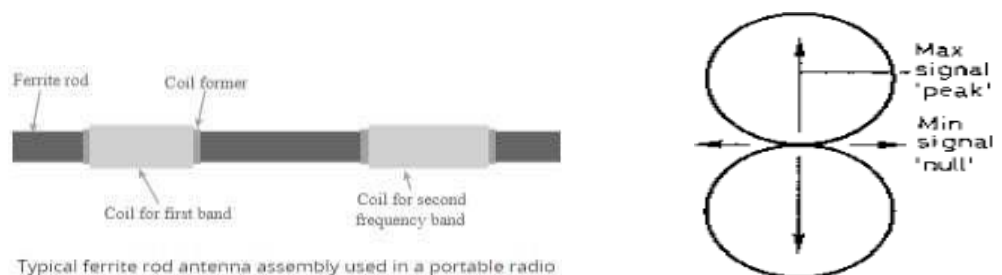

Its advantages are its small size and low cost. The limitations include low efficiency and high power losses.

### Broadside Array

The phasing of linear array elements may be done such that the main lobe of the array pattern lies along the array axis (end-fire array) or perpendicular to the array axis (broad side array). The broadside array is designed such as the radiation pattern's direction is perpendicular or broadside to the array axis. It consists of the dipole elements that are fed in phase and separated by the one-half wave length. A broadside array is used to radiate the energy in a particular direction to make better transmission. It operates in VHF and UHF bands.

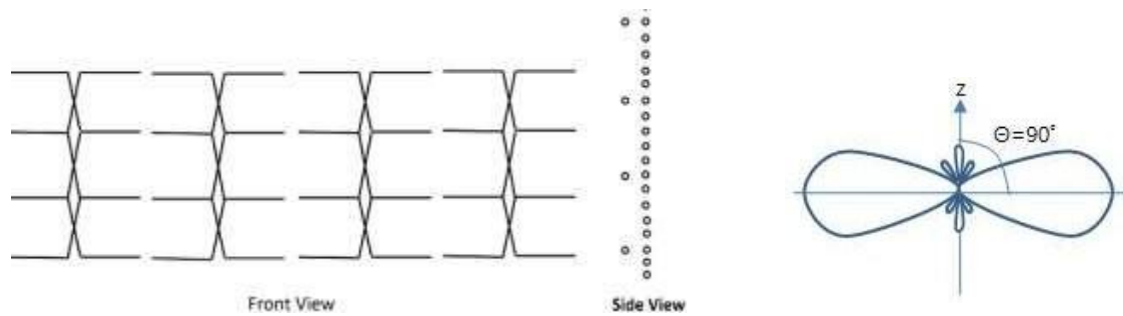

Advantages: high gain and directivity.  
Disadvantages: high complexity and cost.

### End fire array

The physical orientation of end-fire array is same as that of the broad-side array. The magnitude of currents in each element is same, but there is a phase lag between the succeeding elements. So the radiation pattern of the array lies in its plane, not perpendicular to it. It is unidirectional in nature. It is also a type of linear, resonant antenna like broadside array.

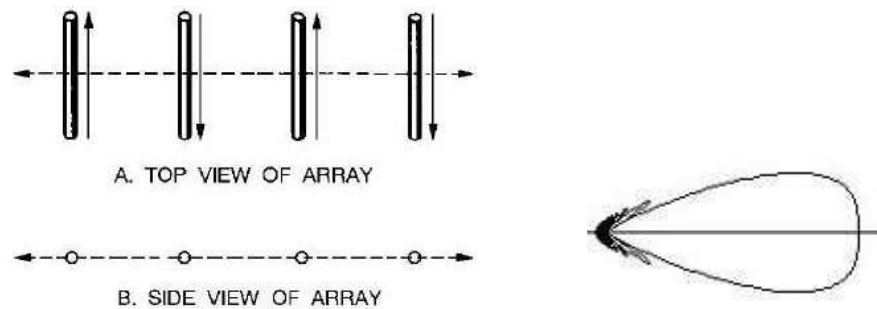

There is nil radiation in the right angles to the plane of the array because of cancellation. The first and third elements are fed out of phase and therefore cancel each other's radiation. Likewise, second and fourth are fed out of phase, to get cancelled. The usual dipole spacing is  $\lambda/4$  or  $3\lambda/4$ . This arrangement helps to avoid the radiation perpendicular to the antenna plane and therefore the radiated energy get diverted to the direction of radiation of the whole array. Therefore, the minor lobes are avoided resulting in increased directivity.

### Rhombic antenna

The Rhombic Antenna is an equilateral parallelogram shaped antenna. It has two opposite acute angles. The tilt angle is approximately equal to  $90^\circ$  minus the angle of major lobe. Rhombic antenna works as a travelling wave radiator. It is placed horizontally above the surface of the earth. The antenna works in HF and VHF ranges. The top view of rhombic antenna is given below.

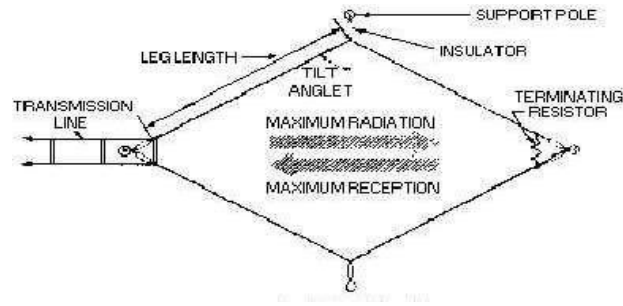

The rhombic antenna is widely used for long-distance, high-frequency transmission and reception, point-to-point communications. The rhombic antenna is much easier to construct and maintain with high gain and directivity.

But a large antenna site is required for its erection. A high-frequency rhombic antenna has wires of several hundred feet in length. Also the horizontal and vertical patterns depend on each other.

The figure below shows the individual and resultant radiation pattern of the antenna:

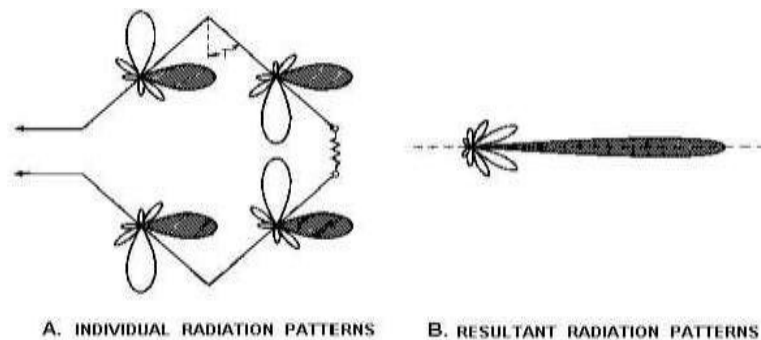

### Parabolic Dish antenna

A parabolic dish antenna is an antenna that uses a parabolic reflector to direct the radio waves. It has high directivity, high gain and narrow beam width. The parabolic reflector must be much larger than the wavelength of the radio waves in order to achieve narrow beam widths.



Standard Parabolic Antenna    Shielded Antenna

Features of Dish antenna are:

1. The basic structure of a parabolic dish antenna is consists of a feed antenna (horn antenna with a circular aperture) pointed towards a parabolic reflector. The working principle of a parabolic antenna is that a point source of radio waves at the focal point in front of a parabolic reflector will be reflected into a collimated plane wave beam along the axis of the reflector and vice-versa.

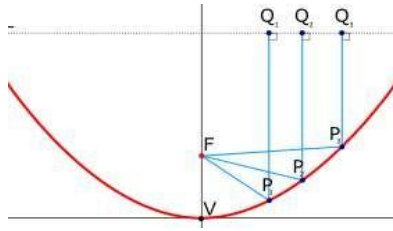

2. Directive gain of parabolic antenna is given by

$$G_a \text{ (dBi)} = 10 \log_{10} \eta \left[ 4 \pi A_e / \lambda^2 \right]$$

Where:

$G_a$  = Antenna Directive Gain

$\eta$  = Aperture Efficiency (50-55%)

$A_e$  = Antenna Aperture Area

$\lambda$  = Wavelength (speed of light / frequency)

3. Advantages: High gain and high directivity.

4. Disadvantages: Requires reflector and drive elements, large size and high cost.

5. Applications: Parabolic antennas are used for point-to-point communications, in microwave relay links to carry telephone and television signals, wireless WAN/LAN links for data communications, satellite communications and spacecraft communication antennas. They are also used in radio telescopes.

6. Feeding methods: Parabolic antennas are classified by the type of feed.

- *Axial or front feed* – The feed antenna is located in front of the dish at the focus, on the beam axis, pointed back toward the dish. The feed and its supports block some of the beam limiting the aperture efficiency to only 55–60%.
- *Off-axis or offset feed* – The focus and the feed antenna, are located to one side of the dish, so as to move the feed structure out of the beam path, therefore it does not block the beam. It is used in home satellite television dishes, multiple reflector designs such as the Cassegrain and Gregorian.
- *Cassegrain* – Here, the feed is located on or behind the dish, and radiates forward, illuminating a convex hyperboloidal secondary reflector at the focus of the dish.
- *Gregorian* – It is similar to the Cassegrain design except that the secondary reflector is concave in shape.

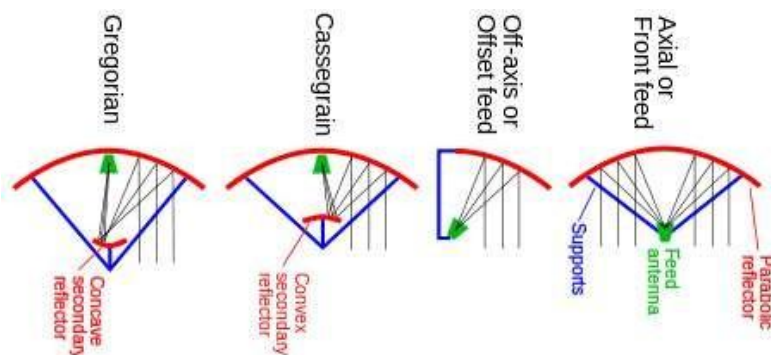

### Patch Antenna

A patch or microstrip antenna is a type of low profile radio antenna, which can be mounted on a flat surface. It consists of a rectangular sheet or patch of metal, mounted over a larger sheet of metal called a ground plane. The patch and the ground plane are separated by a dielectric sheet called as substrate. The radiating elements and the feed line are photo-etched on the substrate. The top and side view of patch antenna is as given below:

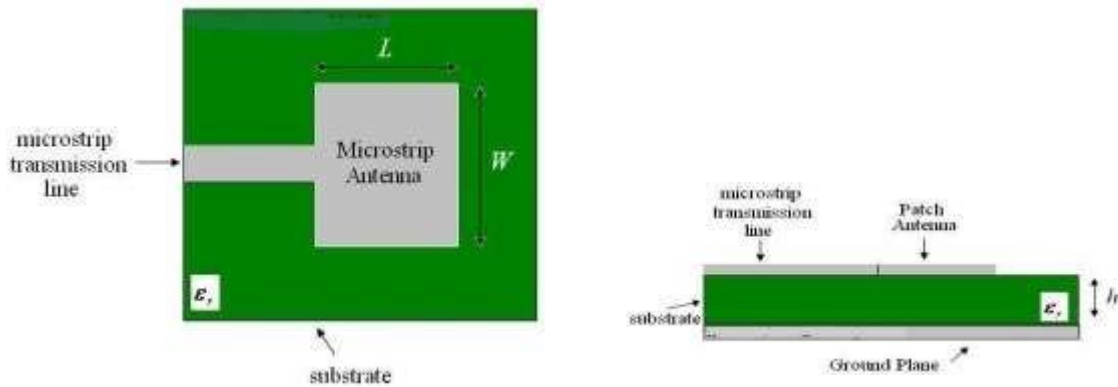

Advantages of patch antenna are its small size, low cost, easy and accurate design, and high directivity.

Disadvantages: narrow bandwidth and low efficiency.

Applications: The patch antenna is mainly used at microwave frequencies in portable wireless devices like mobile phones because of the ease of fabricating it on printed circuit boards.

Multiple patch antennas can be used to make high gain array antennas and phased arrays.

### Multiple Choice Questions

1. Directivity gains depends on
  - a) the distribution of radiated power in space
  - b) solid angle of radiated field pattern
  - c) both a and b above
  - d) none of these
  
2. The antennas having directional properties are known as :
  - a) homogenous
  - b) isotropic
  - c) anisotropic
  - d) oriental
  
3. The total field produced by an antenna array system at a great distance from it is
  - a) Some of the field produced by the individual antenna of the array system
  - b) directional gain of antenna
  - c) linear antenna gain
  - d) vector sum of the field produced by the individual antenna of array system.
  
4. The polarization of electromagnetic waves is in
  - a) Direction of electric field
  - b) Direction of magnetic field
  - c) Direction of magnetic field
  - d) None the above
  
5. In end fire array the principle direction of radiation
  - a) is perpendicular to the array axis
  - b) is perpendicular to the array axis & also to the plane containing the array elements
  - c) coincides with the direction of array axis
  - d) is 45° to the direction of array axis



### **Short Answer Questions**

1. Define antenna
2. What is directive gain?
3. What do you mean by radiation resistance?
4. What do you mean by polarization?
5. Give brief description of board side array and its radiation pattern?
6. Explain the concept of polarization of electromagnetic wave.
7. What is meant by antenna array and explain about end-fire array?
8. What is loss resistance?

### **Long Answer Questions**

1. Explain in detail the rhombic antenna along with advantage and disadvantage.
2. Explain the characteristics and applications of yagi-uda antenna ?
3. Explain in detail the concept of half wave dipole antenna?

## CHAPTER-4 PROPAGATION

### Learning Objectives:

After completion of this chapter, the students will be able to explain various modes of propagation of waves i.e. Ground Wave, Sky Wave, Space Wave and Duct Propagation.

### Introduction

A wave propagates due to refraction, diffraction or scattering. Reflection occurs when a propagating electromagnetic wave strikes an object which has very large dimensions when compared to the wavelength, e.g., buildings, walls. Diffraction occurs when the radio path between the transmitter and receiver is obstructed by a surface that has sharp edges. Scattering occurs when the medium through which the wave travels consists of objects with dimensions that are small compared to the wavelength. The received energy at a distant point may travel over any of the possible modes of propagations: Ground or surface wave propagation, Sky wave or Ionospheric wave propagation and Space wave propagation.

### Ground Wave Propagation

Ground Wave propagation is a method of radio wave propagation that uses the area between the surface of the earth and the ionosphere for transmission. The surface wave can propagate over the earth's surface mainly in the low frequency and medium frequency ranges and used for short distance propagation. If the antennas are in the line of sight then there will be a direct wave as well as a reflected signal. The direct signal is one that travels directly between the two antennas and the reflected signal is received after reflection by the earth's surface and any hills or large buildings etc. The surface wave tends to follow the curvature of the Earth and enables coverage beyond the horizon. Instead of just travelling in a straight line the radio signals tend to follow the curvature of the Earth. This is because currents are induced in the surface of the earth and this action causes the wave-front of the radio communications signal to tilt downwards towards the Earth. With this tilted wave-front, it is able to curve around the Earth and be received well beyond the horizon.

The earth attenuation increases as frequency increases. So this mode of propagation is suitable for low and medium frequency i.e. up to 2 MHz only. It is called as medium wave propagation and is used in local broadcasting.

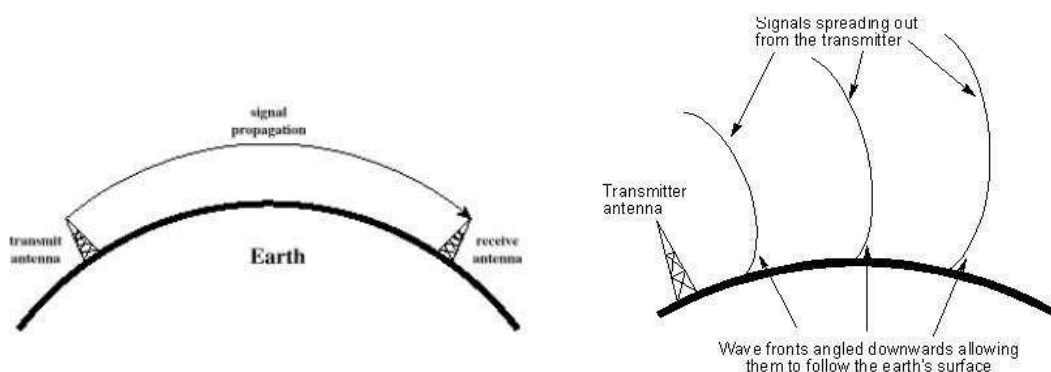

According to the Sommerfield Equation, Electric field strength  $E$  at a distance from transmitting antenna due to ground wave, is given by

$$E = 120 \pi h_t \cdot h_r \cdot I_s / \lambda \cdot d \text{ (volt/meter)}$$

where,  $120 \pi$  – Intrinsic impedance of free space

$h_t$ ,  $h_r$  – Effective heights of transmitting and receiving antennas

$I_s$  – Antenna currents

$d$  – Distance between TX and RX antennas

$\lambda$  – Wavelength

### Space Wave Propagation

Space waves occur within the lower 20 km of the atmosphere and are comprised of a direct and reflected wave. These waves have the ability to propagate through atmosphere, from transmitter antenna to receiver antenna. These waves can travel directly or can travel after reflecting from earth's surface to the troposphere. So, it is also called as Tropospheric Propagation and is used in VHF and UHF bands.

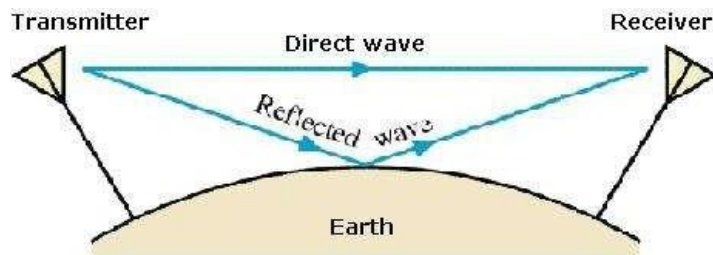

Space wave, comprising direct + reflected waves

At higher frequencies the sky wave propagation and ground wave propagation can't work. These waves are limited to the curvature of the earth and have line of sight propagation. The LOS distance is that distance at which both the sender and receiver antenna are in sight of each other. By extending the heights of both the sender and the receiver antennas, the transmission range can be increased. Its applications are in radar and television communication.

Direct Wave transmission includes line of sight transmission. Due to atmospheric refraction the range extends slightly beyond the horizon.

Ground Reflected Wave occurs when the radio waves strike the earth and bounce off. The strength of the reflection depends on local conditions. The received radio signal can cancel out if the direct and reflected waves arrive with the same relative strength and  $180^\circ$  out of phase with each other. A direct space wave can travel  $4/3$  greater distance than line-of-sight due to diffraction. This distance is known as the radio horizon and can be written as:

$$d \cong 2h_t + 2h_r$$

Where,  $d$  = radio horizon (mi),  $h_t$  = transmitting antenna height (ft),  $h_r$  = receiving antenna height (ft)

### Sky Wave propagation

In this mode of propagation, when the EM waves are radiated towards the sky, they are either refracted or reflected back to the earth by the ionosphere. The height of the ionosphere ranges from 50 to 400 km. Radio waves are refracted by the ionized gas created by solar radiation. The amount of ionization depends on the time of day, season and the position. This ionosphere propagation takes place mainly in the HF band. The ionosphere is composed of several layers. Each layer has different propagation characteristics:

D layer – This layer occurs only during the day at altitudes of 60 to 90 km. High absorption takes place at frequencies up to 7 MHz.

E layer – This layer occurs at altitudes of 100 to 125 km. In the summer, dense ionization clouds can form for short periods. These clouds called *sporadic E* can refract radio signals in the VHF spectrum. This phenomenon allows amateur radio operators to communicate over enormous distances.

F layer - This single night-time layer splits into two layers (F1 and F2) during the day. The F1 layer forms at about 200 km and F2 at about 400 km. The F2 layer propagates most HF short-wave transmissions.

Because radio signals can take many paths to the receiver, multipath fading can occur. If the signals arrive in phase, the result is a stronger signal. If they arrive out of phase with each other, they tend to cancel.

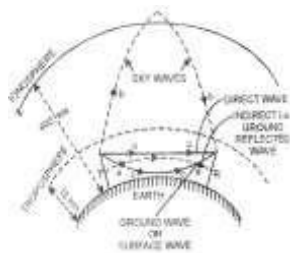

**Ionosphere:** The ionosphere is the ionized part of Earth's upper atmosphere, from about 60 km to 1000 km altitude, a region that includes the thermosphere and parts of the mesosphere and exosphere. The ionosphere is ionized by solar radiation.

**Virtual Height:** The height to which a short pulse of energy sent vertically upward and travelling with speed of light would reach taking same time as the original wave would have reflected from the ionosphere.

**Critical Frequency:** The highest frequency that will be reflected and returned down to the earth by a layer at vertical incidence.

**Multi-path:** The wave, which is reflected from the ionosphere, can be called as a hop or skip. There can be a number of hops for the signal as it may move back and forth from the ionosphere and earth surface many times. Such a movement of signal can be termed as multipath propagation.

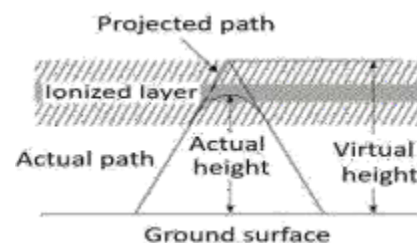
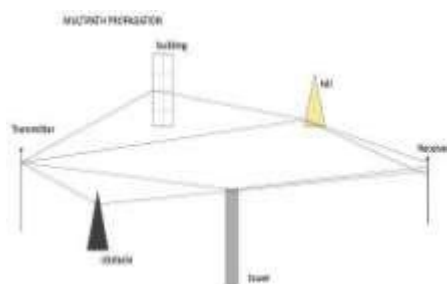

**Fading:** Fading refers to the variation of the signal strength with respect to time/distance. It is widely prevalent in wireless transmissions. The most common causes of fading in the wireless environment are multipath propagation and mobility.

**Skip Distance:** The measurable distance on the surface of the Earth from transmitter to receiver, where the signal reflected from the ionosphere can reach the receiver with minimum hops or skips, is known as skip distance.

**Maximum Usable Frequency (MUF):** It is the highest frequency that can be used to receive sky wave signals at the receiving point.

### Duct Propagation

At a height of around 50 meters from the troposphere, the temperature increases with the height. In this region of troposphere, the higher frequencies or microwave frequencies tend to refract back into the Earth's atmosphere, instead of shooting into ionosphere, to reflect. These waves propagate around the curvature of the earth even up to a distance of 1000km. This refraction goes on continuing in this region of troposphere. This can be termed as Super refraction or Duct propagation.

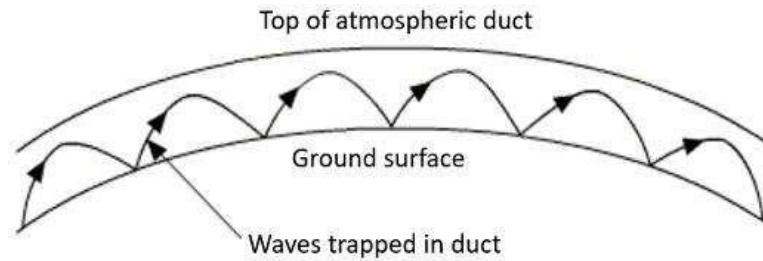

The main requirement for the duct formation is the temperature inversion. The increase of temperature with height, rather than the decrease in the temperature is known as the temperature inversion.

### Multiple Choice Questions

1. What type of propagation uses radio signals refracted back to earth by ionosphere?
  - a) sky- wave
  - b) earth-moon-earth
  - c) ground-wave
  - d) tropospheric
  
2. What type of propagation involves radio signals that travels along the surface of the earth?
  - a) sky-wave propagation
  - b) knife-edge diffraction
  - c) E-layer propagation
  - d) ground –wave propagation
  
3. What is the area of weak signals between the range of ground-waves and the first hop called?
  - a) The skip zone
  - b) The hysteresis zone
  - c) The monitor zone
  - d) The transequatorial zone
  
4. What type of radio wave propagation makes it possible for amateur stations to communicate long distance?
  - a) direct –inductive propagation
  - b) knife –edge diffraction
  - c) ground –wave propagation
  - d) sky-wave propagation
  
5. Ground waves propagate in the frequency range of .
  - a) 3 khz to 30 khz
  - b) 30khz-3mhz
  - c) 3mhz-30mhz
  - d) 30mhz-300mhz

6. The skip distance for radio wave increases with
- a) increase in frequency
  - b) reduce in frequency
  
  - c) temp of atmosphere
  - d) none of the above

### **Short Answer Questions**

- 1. Define maximum usable frequency
- 2. Write the application of ground-waves
- 3. On what factors does skip distance depends?
- 4. Write the disadvantage of ground –wave propagation
- 5. What is ionosphere?
- 6. Explain in the detail the term critical frequency.
- 7. Discuss in brief the propagation characteristics of short waves.

### **Long Answer Questions**

- 1. Explain the concept of ground wave propagation.
- 2. Explain the concept of sky wave propagation.
- 3. Explain in detail the space wave propagation.

## CHAPTER 5: SATELLITE COMMUNICATION

### Learning Objectives:

After completion of this chapter, the students will be able to explain satellite communication link and terms related to it.

### Basic Idea

A satellite is a body that moves around another body in an orbit. A communication satellite is a microwave repeater that helps in telecommunications, radio, television and internet applications. A repeater increases the strength of the signal and retransmits it. It works as a transponder, which changes the frequency band of the transmitted signal also. The frequency with which the signal is sent into the space is called Uplink frequency, while the frequency with which it is sent by the transponder is Downlink frequency.

Advantages of satellite communications are

- Flexibility
- Ease in installing new circuits
- Large Distances covered and cost doesn't matter
- Broadcasting possibilities
- Large coverage
- User can control the network

Drawbacks of Satellite communication are

- The initial costs such as segment and launch costs are too high.
- Congestion of frequencies
- Interference and propagation

*Active Satellite:* The active satellite has its own transmitting and receiving antennas. It amplifies the signal received from earth station or ground station and retransmits the amplified signal back to earth. It also performs frequency translation of the received signal before retransmission. Active satellite can generate power for its own operation. It is also known as active repeater.

*Passive Satellite:* It is basically a reflector which receives the signal from the transmitting earth station and scatters the signal in all the directions. It reflects the electromagnetic radiations without any modification or amplification. Passive satellite cannot generate power of its own and simply reflects the incident power.

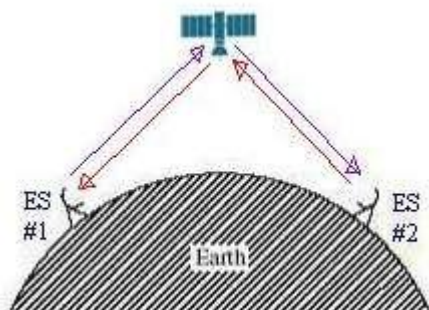

ACTIVE SATELLITE

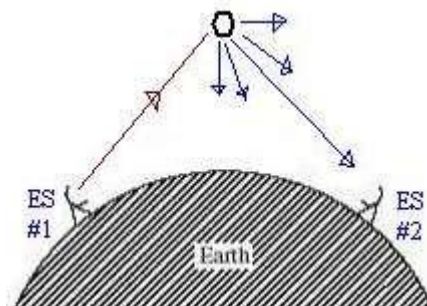

PASSIVE SATELLITE

*Orbit:* A curved path (usually elliptical) followed by the satellite while revolving around the earth is known as orbit. For example, in geostationary satellite, the position of the satellite is constant with respect to earth because its time period of revolution is equal to time period of rotation of earth on its own axis.

*Apogee:* The point in the orbit of the satellite which is at the farthest distance from the centre of the earth is called as Apogee. It is denoted by  $r_a$ .

*Perigee:* It is the nearest point from the earth existing on the satellite orbit and is denoted by  $r_p$ .

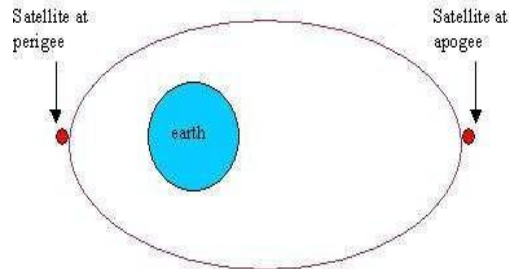

### **Geostationary Satellite and Its Need**

A geostationary satellite is an earth-orbiting satellite, placed at an altitude of approximately 36000 kilometers directly over the equator. It revolves in the same direction the earth rotates (west to east) and takes 24 hours (the same time period as the earth requires to rotate once on its axis). A geostationary satellite appears nearly stationary in the sky when seen by an observer on earth. A single geostationary satellite can cover about 40% of the earth's surface. Hence three such satellites, each separated by 120 degrees of longitude, can provide coverage of the entire planet. It has the main advantage of permanently remaining in the same area of sky, so ground based antennas do not need to track them. The geostationary satellites are needed for weather forecasting, global communication, satellite TV and radio etc.

#### **Satellite Communication link**

Communications Satellites consist of the following subsystems:

- Communication Payload, normally composed of transponders, antennas, and switching systems
- Engines used to bring the satellite to its desired orbit
- A station keeping, tracking and stabilization subsystem used to keep the satellite in the right orbit, with its antennas pointed in the right direction, and its power system pointed towards the sun
- Power subsystem, used to power the Satellite systems, normally composed of solar cells, and batteries that maintain power during solar eclipse
- Command and Control subsystem, which maintains communications with ground control stations. The ground control Earth stations track the satellite performance and monitor its functionality during various phases of its life-cycle.

The available bandwidth depends upon the number of transponders provided by the satellite. Each service requires a different amount of bandwidth for transmission.



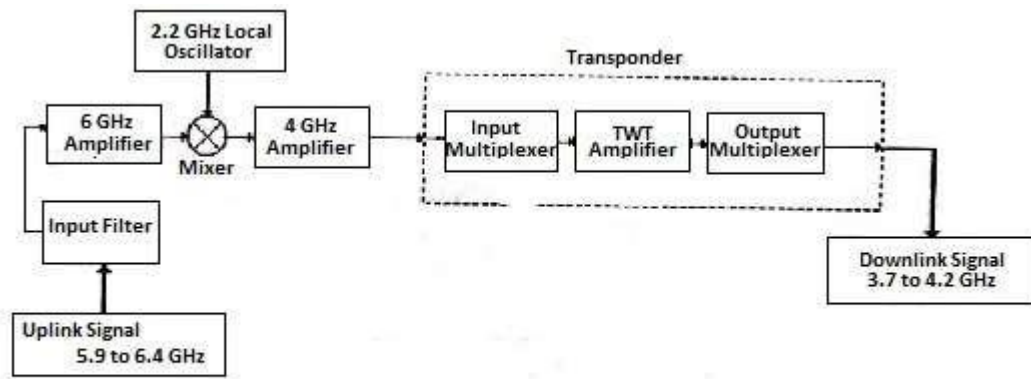

Satellite Communication System Block Diagram

Uplink, downlink filters, amplifiers, local oscillator and transponder are the basic blocks of the satellite communication system. The uplink and downlink frequency ranges are respectively 5.9 – 6.4 GHz and 3.7 – 4.2 GHz. The mixer and local oscillator convert the uplink frequency to lower frequency. The satellite receives the signals transmitted from the ground stations, amplifies it and retransmits it at downlink frequencies to avoid interference. A satellite can have many transponders. The transponder consists of input and output multiplexer and one TWT amplifier.

The block diagram of an earth station and transponder consists of various elements as shown below.

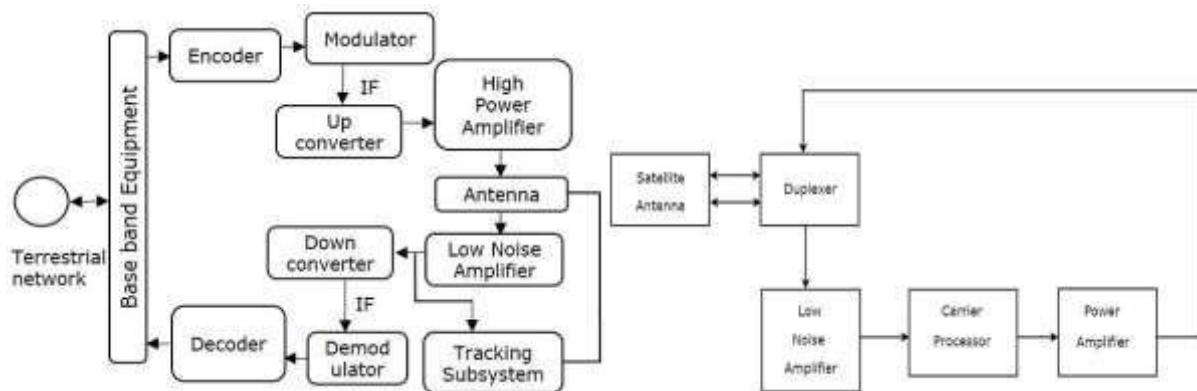

**Earth station:** The input baseband signal from the terrestrial network enters the earth station at the transmitter. The signal is encoded, modulated and up-converted. Then it is amplified and passed through antenna terminal. The signal received from the satellite is amplified in a low noise amplifier, and down-converted. It is then demodulated and decoded to get the original baseband signal.

**Transponder:** Duplexer is a two-way microwave gate. Duplexer receives uplink signal from the satellite antenna and transmits downlink signal to the satellite antenna. The Low Noise amplifier increases the strength of the weak received signal. Carrier Processor carries out the frequency down conversion of received signal (uplink). The power of frequency down converted signal (down link) is amplified to the required level using a suitable power amplifier.

### 5.3 VSAT and its features:

A very small aperture terminal is a satellite ground station with a dish antenna with a diameter of size smaller than 3.8 meters. The VSAT antennas range from 75 cm to 1.2 m. Data speed range from 4 kbit/s up to 16 Mbit/s. VSATs access satellites

in geosynchronous orbit to relay data from small remote Earth stations to other terminals or master Earth station.

### VSAT Network:

- The ground segment of a VSAT network consists of a high performance hub Earth station and a large number of low performance terminals referred to as VSATs.
- The space segment consists GEO satellites acting as communication links between the hub station and the VSATs.
- A typical VSAT network is shown below.

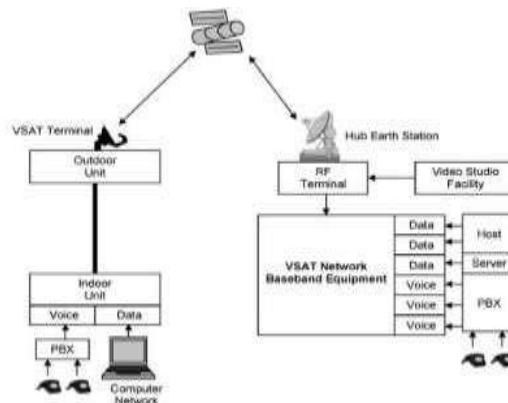

- VSATs use a high performance central station so that the various remote stations can be simpler and smaller in design.
- The hub station is usually a large, high performance Earth Station comprising an outdoor antenna for transmission, RF terminals for providing a wideband uplink of one digital carrier per network, base band equipment comprising modems, and various kinds of interfacing equipment to support a wide variety of terrestrial links.
- The terrestrial links connect the hub station to the head office.
- VSATs are smaller and simpler in design as compared to the hub centre and comprise an outdoor antenna, an RF terminal comprising an LNB for reception and baseband equipment.
- VSAT networks use either C band or Ku band.
- VSATs generally carry digital signals. BPSK or QPSK modulation schemes with forward error correction are often used.
- Applications of VSAT include File transfers, Computer communications, Database enquiries, Video conferencing, Reservation systems, Credit checks and credit card verification, Billing systems, Stock control and management, Electronic mail and Point of sale transactions.

### Multiple Choice Questions:

1. A passive satellite
  - a) Amplifies the signal
  - b) Reflects the signal
  - c) Absorbs the signal
  - d) None of the above
  
2. The source of energy for a satellite is
  - a) Battery
  - b) Fuel cell

- c) Magneto hydrodynamic generator
- d) Solar cell

3. Which of the following bands cannot be used for satellite communication?

- a) MF
- b) Ku
- c) X
- d) C

4. The reason for carrying multiple transponders in a satellite is

- a) More number of operating channel
- b) Better reception
- c) More gain
- d) Redundancy

5. A transponder is a satellite equipment which

- a) receives a signal from Earth station and amplifies
- b) changes the frequency of the received signal
- c) retransmits the received signal
- d) does all of the above-mentioned functions

6. A geosynchronous satellite

- a) has the same period as that of the Earth
- b) has a circular orbit
- c) rotates in the equatorial plane
- d) has all of the above

### Short Answer Questions

1. What is geostationary satellite?
2. Differentiate between active and passive satellites.
3. Define and explain orbit, apogee and perigee.
4. Write applications of VSAT.

### Long Answer Questions

1. Explain the block diagram of communication link.
2. Explain the VSAT operation and features.