

Self Learning Module

Introduction, classification,

Properties and testing of Refractories

MODULE I

CERAMICS REFRACTORY TECHNOLOGY I

**INTRODUCTION TO REFRACTORIES, CLASSIFICATION,
PROPERTIES AND OCCURANCE OF RAW MATERIALS**

**Developed By Ashwani Kumar student of M.Tech Engg.
Education as a part of teaching methodologies for 4th semester
students of Ceramics Technology in the subject Ceramic
Refractory Technology - I**

PREFACE

In today's world the traditional methods of teaching learning are largely replaced by many innovative method of learning. The technology is playing a bigger role to put the learner at alternative learning, put the learner at convenience of time, place, pace and flexibility of course curriculum as well as the teaching learning process.

Though the methods of delivery of education are rapidly changing, self learning module is still one of the most effective methods to learn how things work in any of the area of education or training.

Refractories although traditional ceramics, but still it is inevitable material which is being used in many industries involving metallurgical operations and other high temperature operations and hence considered as one of the important field of ceramics.

To enhance the capabilities of students in the area of Refractories a small but earnest attempt is made through this self learning module. I hope it should be helpful and handy to reach large number of students so that it might develop basic skills and competencies in the area of Refractories.

ASHWANI KUMAR

CONTENT	PAGE
Purpose of module	1/0/1
Objective of Module	1/0/1
Content of module	1/0/2
How to use this module	1/0/3
References	1/0/4

PURPOSE OF THE MODULE

Being a ceramic student you will probably be interested to know Refractories. It is important that you must develop basic understanding of Refractories. The purpose of this module is to provide basic knowledge and understanding of Refractories.

OBJECTIVES OF MODULE

By the end of the module you will be able to

1. Understand the concept of Refractory.
2. Understand the classification of Refractories.
3. Understand various properties of Refractories.
4. Know raw materials places of occurrence.
5. Know manufacturing units in India.
6. Understand various testing procedures of Refractories.

CONTENTS OF MODULE

This module has been divided into units, each of which is presented in separate sections.

The titles of these units are as follows

- UNIT I INTRODUCTION TO REFRACTORY
- UNIT II CLASSIFICATION OF REFRACTORIES
- UNIT III PROPERTIES OF REFRACTORIES
- UNIT IV OCCURENCES OF RAW MATERIALS AND
 MANUFACTURING UNITS IN INDIA

HOW TO USE THIS MODULE

If you want to gain maximum benefit from this module, you will have to follow instructions carefully. To help you to use the module properly, the key points you need to be familiar with are summarized below.

1. The module is divided into six units.
2. Pages are numbered according to the module and units. For example

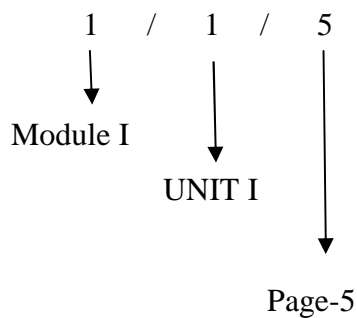

3. The topics in the module are numbered using points. These points indicate the unit number, topic and sub-topic. For example 1.2.3 indicates first unit, second topic or section and third sub topic or sub section.
4. After the first page of every unit, you will find the content of that unit.
5. On the next page of each unit, you will find the general and specific objectives for that unit. Read them carefully.
6. Each unit has sequence of activities

 **OBJECTIVES:** These are general and specific objectives for that unit.

 **INPUT:** This contains new information for you to learn

 **PRACTICE TASK:** Here you are presented some tasks based on input which you must complete.

 **FEEDBACK TO PRACTICE TASK :** This contains the correct answers to the practice task.

7. You must work through each unit in the sequence in which it is presented. After going through the input, do the practice task. Look at the feedback to the practice task only after you have completed the practice task.
8. Read your own.
9. Begin working on the next unit in the module only after you have completed the previous unit and you are confident that you have achieved the objectives of unit.

REFERENCES

You may wish to follow up some of the things that you will learn in this module. To help you to do this a list of useful references is given below:

1. CHESTI, R. Refractories Manufacturing, Properties and Applications,
Prentice Hall of India Private Limited, New-Delhi (1986)
2. KHANNA, O.P. Elements of fuels, furnaces and refractories,
Khanna Publishers, New delhi (2002)
3. CHESTERS, J.H Refractories, Production and Properties,
Iron and steel institutes, London(1973)
4. NANDI, D.N. Handbook on Refractories,
Tata McGraw-Hill Publishing Company, New-Delhi(1991)
5. NORTON, F.H. Refractories, McGraw Hills company, New York (1980)

MODULE I
UNIT I

CERAMICS REFRACTORY TECHNOLOGY I

**INTRODUCTION TO REFRACTORIES, CLASSIFICATION,
PROPERTIES AND OCCURENCE OF RAW MATERIALS**

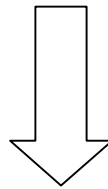

INTRODUCTION TO REFRACTORIES

CONTENT

PAGE



OBJECTIVES

1/1/3

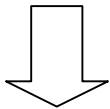

INPUT : Introduction to Refractories

1/1/4

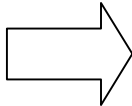

PRACTICE TASK

1/1/7



FEEDBACK TO PRACTICE TASK

1/1/8

UNIT I Introduction to Refractories

OBJECTIVES

GENERAL OBJECTIVE: Understand the concept of Refractory.

SPECIFIC OBJECTIVES: At the end of this unit , you will be able to:

- Explain the concept of Refractories.
- Explain the importance of Refractories.

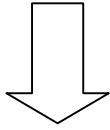

INPUT

1.1 Introduction

Let us learn one of the important fields of ceramics. Without this many of the industrial operations involving high temperature are not possible. Not only this, these are also integral part of space vehicle used by scientists to explore universe. Every student of Ceramic Technology must have knowledge of these materials. Do you want to know what it is?

These materials are called Refractories. Visit any industry dealing with treatment of ores or other materials for manufacture of metallurgical, chemical and ceramics products. You will observe that, most of such industries involve high temperature operations along with other working conditions such as corrosive, erosive and load conditions

After observing all these conditions, you might be thinking how these equipments are able to withstand at such high temperature and other working conditions without deteriorations? Why heat losses in these equipments are low, as these are able to maintain high temperature? The answer to your question is because all such type of equipments use “Refractories”. All such industries involving high temperature operations depend on the Refractories materials or bricks made by Refractory industries.

Now you must have understood that “Refractories” are the materials which protect industrial equipments (generally kilns or furnaces) and vessels. From industrial point of view, Refractory materials are those which do not soften by fusion at working temperature. The important features of Refractories, therefore are excellent resistance to heat and thermal shock, chemical attack (corrosive action of slag's or molten mass, fluxes or furnaces atmosphere), resistance to abrasion by the charge or the flue gases, moving solid particles or molten mass, dust laden gases at high temperature. They should also bear the load at ordinary temperature and must not deform under load at high temperature also.

The principal raw materials used in the production of Refractories are the oxide of silicon, aluminum, magnesium, calcium and zirconium. Some other non-oxide materials like carbides, nitrides, borides and graphite.

Now look at figure 1.1, figure 1.2 and figure 1.3, these are some shapes how Refractories look like.



Fig 1.1: Fireclay Bricks



Fig 1.2: Different shapes of refractories for lining

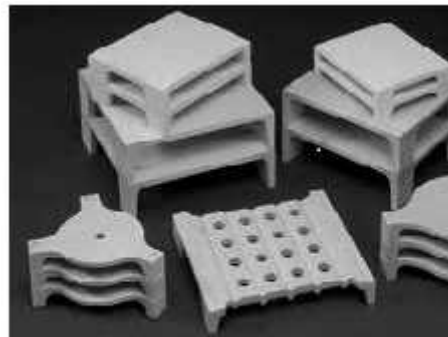

Fig 1.3: Different shapes used as kiln furniture

Figure 1.1 shows fire clay bricks which are used as lining, figure 1.2 shows different shapes of Refractories used as kiln lining and figure 1.3 shows different shapes of Refractories used as kiln furniture.

1.2 Definition of refractory

Now let us define the term refractory. Refractories are the materials which are “hard to fuse”

OR “The Refractories are class of materials which can withstand at high temperature without fusing, resist the action of corrosive liquids and dust laden currents of the hot gases”. In technological terms Refractories refer to the materials used to make furnaces, kilns, stoves, driers and critical parts of air craft, jet engines and aerospace craft operating at high temperature.

1.3 Importance of Refractories

Before proceeding further, we need to know where exactly the Refractories are used. Since Refractories protect kilns, furnaces & vessels, for that these must be in contact with materials placed in the kilns or furnaces and vessels. So Refractories must

- (i) Bear conditions of high temperature
- (ii) Resist then action of corrosive liquids and dust laden hot gases.

The Refractories are used in

(i) **Metallurgical industries** for the internal lining of furnaces or kilns, reactors and other vessels holding and transporting metal and slag. In such industries iron and steel industry is the greatest consumer of Refractories. It takes away about 70-75% of the total production of Refractories.

(ii) **Non-metallurgical industries** the Refractories are mostly installed on fired heaters, hydrogen reformers, ammonia primary and secondary reformers, cracking furnaces etc. Some Refractories are also used as kiln furniture. These are used to carry raw material for firing. Majority of these equipments operate under high pressure and temperature. The operating temperatures can vary from 900 to 2900 °C. Refractories must withstand over and above this temperatures. Table 1.1. enlist the sample melting temperatures of key metallurgical elements where refractory applications are critical.

Table 1.1 Melting Temperatures of some key metallurgical elements

Key Materials	Melting Temperatures in degree F
IRON	2800
NICKEL	2650
COPPER	1980
ALUMINIUM	1220
ZINC	780
LEAD	620
TIN	450

India has excellent and huge deposits of raw materials for Refractories. In the industrialization of a country, refractory play an important role. Steel forms its backbone. All metallurgical industries, glass, enamel, pottery, white ware, cement, power generation etc. ultimately depend upon supply of Refractories. Progress in iron and steel industry depends on Refractory industry.

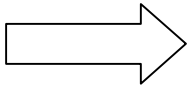

Now do the following practice task

1. Explain the term Refractory.
2. State the two uses of Refractories in non – metallurgical industries.
3. Name type of industry which is the largest consumer of Refractory.

NOW CHECK YOUR RESPONSE

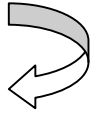

FEEDBACK TO THE PRACTICE TASK

1 Refractories are the materials which can withstand high temperature without fusing. They have excellent resistance to heat, chemical attack, dust laden and other load conditions. These are used to protect equipment and vessels in the industry.

2. (i) Fired heaters

(ii) Hydrogen reformers

3. Iron and steel industry

MODULE I
UNIT II

CERAMICS REFRACTORY TECHNOLOGY I

**INTRODUCTION TO REFRACTORIES, CLASSIFICATION,
PROPERTIES, OCCURENCE OF RAW MATERIALS
AND TESTING**

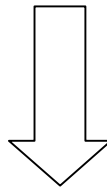

CLASSIFICATION OF REFRACTORIES

CONTENT

PAGE



OBJECTIVES

1/2/3

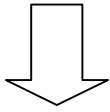

INPUT : Classification of Refractories

1/2/4

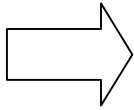

PRACTICE TASK

1/2/7



FEEDBACK TO PRACTICE TASK

1/2/8

UNIT II Classification of Refractories

OBJECTIVES

GENERAL OBJECTIVE: Understand classification of Refractories.

SPECIFIC OBJECTIVES: At the end of this unit , you will be able to

- List various categories of classification.
- Explain each category of classification.

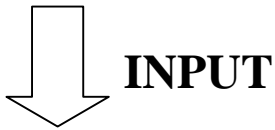

1.2 Classification of Refractories

You can classify Refractories on the basis of chemical composition, method of manufacture and physical form as shown below

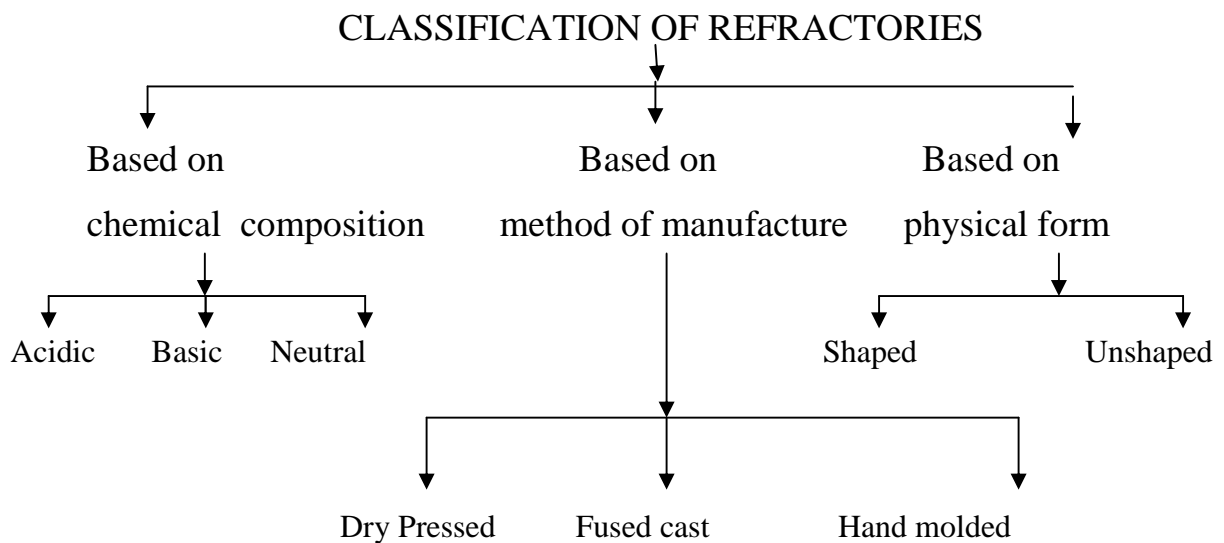

Figure 2.1

1.2.1 Classification based on chemical composition

Refractories can be classified on the basis of their chemical behavior i.e., their reaction to the type of slag's. Accordingly refractory materials are of three classes, namely Acidic, Basic and Neutral. Characteristics features and examples of each type is listed in table 2.1

Table 2.1: Acidic, Basic and neutral Refractories

Refractory class	Characteristic Features	Examples
Acidic Refractories	<ul style="list-style-type: none"> ❖ Attacked by basic slags (alkalies)but not by acidic slags(alkaline). ❖ Used in places where slag and atmosphere are acidic. 	Fireclay(Low heat duty, intermediate heat duty, high heat duty ,super duty) Silica, Semi silica, Kyanite, Sillimanite,high alumina refractory etc
Basic Refractories	<ul style="list-style-type: none"> ❖ Attacked by acidic slags, but are not attacked (stable) by basic (alkaline) slags, dusts, and fumes at elevated (high) temperature. ❖ Used in furnace where environment is basic (alkaline). e.g., non-ferrous metallurgical operations. ❖ Have high coefficient of thermal expansion but not much resistant to thermal shock. Hence they are not used generally for intermittent (batch) kilns 	Magnesite, Dolomite, Magnesite-chrome, Chrome- magnesite refractory etc
Neutral Refractories	<ul style="list-style-type: none"> ❖ Neither attacked by acidic slag's nor by basic slag's. ❖ Stable to both acids and bases and are used in areas where slag and atmosphere are either acidic or basic 	<p>Various forms of carbon(graphite, charcoal and coke), Chromite,</p> <p>Artificial or synthetic refractories(zirconium carbide, titanium carbide and silicon Carbide),</p> <p>Metals(iron, copper, molybdenum, nickel, platinum, osmium, tantalum, thorium, tungsten, vanadium and zirconium) and materials(chromite, zirconia, silicon carbide)</p>

1.2.2 Classification based on method of manufacture

Another way of classifying Refractories is by the manner in which they are shaped. The Refractories can be manufactured by either of the following methods.

1.2.2.1 Dry pressed Refractories these are those which are pressed with the help of hydraulic or mechanical press in dry state.

1.2.2.2 Hand molded Refractories these are molded in wooden moulds in plastic condition.

1.2.2.3 Fused cast Refractories these are those which are first melted and then casted in desired shapes.

1.2.3 Classification based on physical form

Refractories can also be classified according to physical form. These are

1.2.3.1 Shaped

1.2.3.2 Unshaped Refractories.

The former is commonly known as refractory bricks and the later as “monolithics” Refractories.

1.2.3.1 Shaped Refractories

Shaped Refractories are those which have fixed shape. These are also called wall bricks. Bricks shapes can be standard shapes and special shapes. Standard shapes has dimensions that are conformed to by most refractory manufacturers and are generally applicable to kilns and furnaces of same type. Whereas special shapes are specifically made for particular kiln and furnaces. This may not be applicable to another furnace or kilns of same type.

1.2.3.2 Unshaped Refractories

Unshaped Refractories are without definite form and are only given shape upon application. These are categorized as Plastic Refractories, ramming mixes, castables, gunning mixes, fettling mixes and mortars.

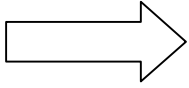

Now do the following practice task

1. Differentiate between acidic and basic Refractories.
2. Classify Refractories on the basis of method of manufacture.
3. Give two examples of neutral Refractories.

NOW CHECK YOUR RESPONSE

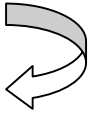

FEEDBACK TO THE PRACTICE TASK

1 **Acidic Refractories** are those which are attacked by acids and are used where slag and/or atmosphere are acidic. Examples of acidic Refractories are fireclay refractory, silica refractory, semi silica refractory, Kyanite refractory, Sillimanite refractory etc.

Basic Refractories are those which are attacked by bases and are used where slag and/or atmosphere are basic. Examples of basic Refractories are magnesite refractory, dolomite refractory, magnesite-chrome refractory, chrome-magnesite refractory etc.

2 The refractories can be classified on the basis method of manufacture as

- (i) Dry pressed refractories
 - (ii) Hand molded refractories
 - (iii) Fused cast refractories
3. (i) Graphite,
(ii) Chromite,



MODULE I
UNIT III

CERAMIC REFRACTORY TECHNOLOGY I

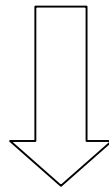
**INTRODUCTION TO REFRACTORIES, CLASSIFICATION,
PROPERTIES AND OCCURENCE OF RAW MATERIALS**

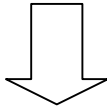

PROPERTIES OF REFRACTORIES

CONTENT	PAGE
 OBJECTIVES	1/3/3
 INPUT : PROPERTIES OF REFRACTORIES	1/3/4
 PRACTICE TASK	1/3/11
 FEEDBACK TO PRACTICE TASK	1/3/12

UNIT III Properties of Refractories

OBJECTIVES

GENERAL OBJECTIVE: Understand various factors affecting selection of Refractories.

SPECIFIC OBJECTIVES: At the end of this unit, you will be able to

- Enlist various properties of Refractories
- Explain various properties of Refractories
- Select appropriate type of Refractories for specific use.

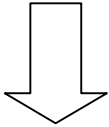

INPUT

1.3 Properties of Refractory materials

If you visit industries involving high temperature operations, you will observe that all these operations are not alike. They vary in terms of temperatures, nature of material being processed, size, atmospheric conditions etc. Can you use same refractory material in all such operations? Certainly not, because no single refractory material is suitable for all applications. The suitability of refractory for particular application depends on physical, chemical and mineralogical properties. Not only this, quality of Refractories also depends on properties and its values. The most common properties and factors that are considered in selecting the optimum refractory lining are discussed below

1.3.1 Refractoriness

It is the ability of a material to withstand high temperature without getting deform or getting fused. It may also be called fusibility of material. This temperature can be found with the help of pyrometer or in terms of the pyrometric cones, called pyrometric cone equivalent (P.C.E.) value. The refractoriness of few pure refractory materials are given in table 3.1

Table 3.1 Refractoriness of some pure refractory materials

Refractory material	Refractoriness
Graphite carbon pure	3600 °C
Thoria	3000 °C
Lime(CaO)	2570 °C
Alumina(Al ₂ O ₃)	2050 °C
Fireclay(25-30% Alumina)	1650 °C
Fireclay(35-40% Alumina)	1720 °C
Silica	1710 °C
Mullite	1810 °C
Silicon Carbide	2240 °C

The refractoriness serves sufficient basis for considering thermal stability of refractory material. This indicate the maximum temperature up to which we can use any refractory material. In labortary, P.C.E. of a refractory is determined by comparing the softening of a test pyramid cone with that of standard pyramid cones of known fusion points under similar conditions. The number of standard pyrometer cone in terms of ASTM cone no. and their corresponding softening point are given in table 3.2

Table 3.2 Refractoriness of Standard Pyrometric Cones

ASTM CONE NO. (STANDARD)	REFRACTORINESS(°C)
18	1522
19	1530
20	1540
23	1560
26	1646
27	1659
29	1665
31	1683
32	1710
33	1730
34	1785
35	1804
36	1820
37	1835
38	1855
39	1875
40	1900
41	1940
42	1980

1.3.2 Refractoriness Under Load (R.U.L.)

It is the property of refractories by virtue of which it resists the combined effects of heat and load lying on this. R.U.L. is of more practical significance than its refractoriness. When the refractories are used in furnaces or kilns in various industries the refractory brick may face the action of various types of mechanical load, tension, compression, scratching, abrasion and also thermal shock. The bottom row of bricks in furnaces or kiln may experience very high pressure due to furnace wall.

The RUL is usually tested under load of 2 kg/cm^2 for dense refractories such as fire bricks and 1 kg/cm^2 for insulating(porous) bricks by heating a test brick or block at a gradually rising temperature in RUL furnace. The temperature at which the test specimen starts to deform or sag and eventually fail usually due to shearing is called RUL

When a refractory test cone is heated, its lowest melting constituents fuses first. Some fused mass therefore is present in it long before the fusion point of the refractory cone is reached and that the test cone bends and flattens only when the amount of fused mass has increased considerably at the expense of the solid and more refractory grains. When a slight pressure is applied during heating of the refractory cone then in that case grains will be forced to slide or slip as soon as some fused mass is formed to separate the solid grains thus resulting in the failure of test cones. So the refractory materials should have either high refractoriness or low fusing constituents (glass) to meet prevailing furnace conditions. The refractoriness in general are made up of two, constituent compounds, fail

under load conditions at temperature much lower than the fusion point of the highest melting and predominant(major) constituents. So the RUL of a refractory is much lower than corresponding refractoriness. For example refractoriness of silica brick is 1710 °C where as RUL is 1650-1660 °C at 2 kg per centimeter square.

The failure of refractory is also influenced by time of its exposure to heat and load. Even refractory containing small yet viscous fused glass will also fail with their prolonged exposure even at safe load and temperature conditions. Like ways increased load or temperature will cause failure at much lower temperature.

1.3.3 Porosity

It is the percentage relationship between the volume of open pore space and the total volume of the refractory. The porosity of refractories determine other properties like slag resistance and spalling resistance. The pores in a refractory material may result as a deliberate addition of various additives. These additives include saw dust, cork and other combustible material. The porosity can also be developed by foaming methods. Increasing the porosity normally reduces the strength.

Porous refractories have high permeability and hence poor resistance to penetration of molten slag, metal and flue gases. Porous refractories act as a good insulator. They have low strength and cannot be used for tall structures.

Porosity is of two types

1.3.3.1 Apparent porosity

1.3.3.2 True Porosity

1.3.3.1 Apparent Porosity

Apparent porosity is the percentage relationship between the volume of open pore space and the total volume of the sample. It can be determined by formula

$$\text{Apparent Porosity} = \frac{W-D}{W-S} \times 100$$

Where D = the constant weight of the Dry Sample

S = the weight of specimen suspended in water

W = the weight of specimen in air including the moisture in its open pores.

1.3.3.2 True Porosity

is the percentage relationship between the volume of combined open and closed pore space and the total volume of the sample.

The porosity of insulation brick can be as high as 80%. Fire bricks have porosity of 15-28% . High density products have low density of 2-5 %

1.3.4 Density

Is defined as mass per unit volume. There are two types of density,

1.3.4.1 Bulk density

1.3.4.2 True density

1.3.4.1 Bulk Density is the weight per unit volume of refractory sample including volume of open pores space. This factor is very important for overall weight lying on the foundation of a refractory structure. It is the factor which limits the size of furnace. The furnace structure made by non-porous refractories should be stronger than structures made up of porous refractories to bear the heavy load lying on it.

Bulk density can be determined by the formula

$$\text{B.D.} = \frac{D}{W-S}$$

1.3.4.2 True density is the ratio of weight of material to its true volume containing open and closed pore space.

Bulk density is generally considered in conjunction with apparent porosity. It is a measure of the weight of a given volume of refractory. For many refractories, the bulk density provides a general indication of the product quality. While evaluating a refractory brand or comparing several products of equivalent type (except insulating type), it is considered that the refractory with higher bulk density (generally with lower porosity) will be better in quality. The structure of a refractory having higher bulk density will be denser, resulting in better resistance to chemical attack, decreased metal penetration, better abrasion resistance and other related benefits. Bulk density of some refractories are given in table number 3.3

Table : 3.3 Bulk density of Some Refractories

Name of refractory	Bulk Density in gm/cc
Silica	1.73
Chrome magnesite	1.93
Fire clay	2.00
Magnesite	1.93
Dolomite	2.58
Fused alumina	2.90
Semi-Silica	3.00

1.3.5 Permeability

Permeability of a material is the volume of the fluid which will pass through one centimeter cube of a material under a pressure of one cm of water in one second. Refractories which come directly under the influence of gases and liquids should be impermeable. It will eliminate the leakage of gases and penetration of liquids through the walls of a furnace or refractory structure. There is no direct dependence of permeability on porosity. Uniform permeability is an indication of absence of internal cracks.

1.3.6 Spalling resistance

It is also called thermal shock resistance or thermal fatigue resistance. It is defined as the fracture of the refractory brick or block. It is the ability of refractories to retain their original form without cracking, splitting or flaking when subjected to sudden changes in temperature.

A refractory may spall due to different reasons:-

1. Failure may occur due to temperature gradients due to uneven heating or cooling of refractory. This sets up stresses causing failure(thermal spalling). This type of failure is common in silica, magnesite and chrome refractories .
2. When refractories are made from non-uniform raw materials having variations in CTE.
3. Structural changes occurring in refractory during service can result in fracture. This can be controlled by proper mixing of raw materials, burning refractories at higher temperatures and preventing slag penetration as far as possible.
4. On heating refractory its grains expands. This result in compression of structure of refractory. This may result results in failure due to shear. Due to this reason refractory made from materials having low coefficients of thermal expansion and coarse textures, have increased resistance to sudden changes in temperature.
5. Diffusivity also influences spalling resistance. Greater the diffusivity greater will be the spalling resistance and vice-versa. Diffusivity leads to equalization of temperature and hence less temperature gradient. Fireclay, zirconia, high alumina have better spalling resistance than that of silica, magnesite and chromite refractories.

1.3.7 Slag resistance

It is very important property of refractories and depends on the nature of slag and refractory which comes in contact with each other. There are two processes of refractory destruction. One is corrosion i.e., chemical reaction and other is erosion i.e., process of breaking and washing away of refractory materials by molten slag or molten metal. The destruction of refractory depends on many factors, which are as follows

1. The temperature and temperature gradient.
2. The chemical and mineralogical composition of slags and lining.
3. Porosity of the lining and sizes and shapes of its pores.
4. Lining is wetted by the slags or not.
5. Viscosity of the slags.
6. Composition of the gaseous atmosphere in the furnace.
7. The rate of reaction between slag and lining.

At high temperature slag always attacks refractory. Slag action also occur when slag material is capable of forming new compounds with refractory materials. The film of slag in contact with the refractory dissolves some of the refractory. Its composition changes(may be to very small extent),this results in lowering or rise of melting temperature of slag film. If its melting temperature is raised the films becomes highly viscous, sticky, inactive and incapable of dissolving the refractory any further. It protects the refractory wall as long as slag films does not get detached from the refractory surface. This viscous film gets diffused into slag very slowly and diluted by fresh slag. It becomes less viscous and fluid enough to further attack the refractory.On the other hand when the melting point of the slag films gets lowered by the dissolved refractory, the

films becomes more fluid. Due to this its rate of diffusion into slag increases and hence it is replaced by fresh slag rapidly. This results increase in slag attack. Acidic refractory addition to acidic slag and basic refractory addition to basic slag increases the melting point. However Basic refractory addition to acidic slag and acidic refractory addition to basic slag lowers melting point. So basic slag attacks acid refractory and acidic slag attack basic refractory very rapidly. A neutral refractory is very useful because it resists both acidic and basic slags roughly to same degree

1.3.8 Cold crushing strength

Cold crushing strength of a refractory material represents its strength or how strong the brick is. In other words it tells how much load it can withstand in cold condition. It is the load in pounds per square inch or kilogram per square centimeter, at which the refractory breaks. Dense and fine grained refractories have good crushing strength. However porous and coarse grained refractories have poor crushing strength.

Can you guess what exactly it indicates? It indicates the maximum combined load (charge and refractory lining) a refractory can withstand. So this property puts restriction on capacity and size of equipment.

1.3.9 Abrasion resistance

The abrasion resistance of a refractory is very important especially when refractory lining comes in contact with moving charge which rubs against it and subjects it to wear. E.g. blast furnace. Abrasion resistance largely depends on hardness and the bonding between particles of the refractories. So under these conditions the refractories must be dense, fine grained and wear resistant refractory lining to ensure the resistance to abrasion. The abrasion resistance diminishes if the surface of refractory lining is softened.

1.3.10 Erosion resistance

It is the measure of resistance offered by a material to the chipping off the particles from it. Erosion takes place when molten metal or gas carry dust and slag particles. When these slag and dust particles strikes against refractory lining it results in chipping off particles from it. Splashing of slag erodes the refractory walls whereas slag particles carried along by flame or gases erode the arches and bends of the structure in particular.

1.3.11 Thermal expansion

It is the internal property of the refractory products to expand on heating and contract on cooling. As you can deduce, this property determines the structural stability of equipment. Can you think of how? This is so because refractories are closely packed in equipment with little space in between. If given refractory expand or contract more than expected, it can lead to failure of structure.

1.3.12 Modulus of rupture (MOR)

It is the flexural breaking strength of a refractory. It is measured at room temperature and expressed in kilogram per square centimeter.

1.3.13 Thermal conductivity

It is the ability of a material to conduct heat and is measured by coefficient of thermal conductivity. Thermal conductivity depends upon the chemical and mineralogical composition of refractories and porosity. As the porosity increases the thermal conductivity decreases. The refractories having air entrapped in their pores behave like insulator.

Refractories having low thermal conductivities are used in melting furnaces to ensure least heat losses. However refractories used in heat recuperators should have high thermal conductivities to ensure maximum heat transfer. Most refractories are poor heat conductors, but graphite, magnesite and silicon carbide are good heat conductors. Insulating materials have low thermal conductivity. Can you think why it is so?

1.3.14 Electrical conductivity

Refractories should have high electrical conductivities when these are used in electrical furnaces as heating elements e.g. silicon carbide. Graphite and metals are good electrical conductors among refractories. Other refractories are electrical insulators. The refractory based in electrical furnace lining should have very low electrical conductivity. Graphite is used as electrodes either in prebaked form or as lining in high temperature electrical furnace. Electrical conductivity also depends on the porosity and porous bodies are less conductive.

1.3.15 Thermal expansion

It is the internal property of refractory products to expand on heating and contract on cooling. As you can deduce, this property determines the structural stability of equipment. Can you think of how? This is so because refractories are closely packed in equipment with little space in between. If given refractory expand or contract more than expected, it can lead to failure of structure.

1.3.16 Price

Cost of refractories is one of the important parameter in selection of refractories. It should be low as possible. A costlier refractory having longer life may prove to be cheaper in the long run than a refractory with lower initial cost.

Students after understanding different parameters and properties of refractory materials, you have fair idea how to select a refractory for particular application. But the selection process is not so easy. For example we want to have material having high abrasion resistance as well as high slag resistance and at the same time high insulation power. For such application you have to choose refractory material having high porosity and high bulk density. Is it possible? Certainly not. For refractory to have high bulk density, refractory must have low porosity. This is so because both are inversely related. Can you think of more such examples?

From above it is clear that properties of refractories play important role in its selection for particular application. So during manufacture of refractories its properties are carefully determined to ascertain its value and to control the variation. Do you know how these properties are assessed? Testing is the tool to assess these properties. Unit No 5 will deal with various methods of testing finished products.

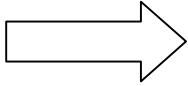

Now do the following practice task

1. Which property determines the maximum temperature up to which furnace or kiln can be used.
2. Define apparent porosity
3. Which property put a limit on the Capacity and size of the equipment in which refractories are used .
4. Which property determines the combined effect of heat and load.
5. Name three properties of refractories that changes with temperature.
- 6 Write the refractoriness value of silica brick.
7. Which property is responsible for change in size of refractory piece during heating and Cooling.
8. Explain erosion of refractories.
9. Why the thermal conductivity decreases with increase in porosity.

NOW CHECK YOUR RESPONSE

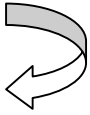

FEEDBACK TO THE PRACTICE TASK

1. Refractoriness.
- 2 Apparent porosity is the percentage relationship between the volume of open pore space and the total volume of the sample. It can be determined by formula

$$\text{Apparent Porosity} = \frac{W-D}{W-S} \times 100$$

Where D = the constant weight of the Dry Sample
 S = the weight of specimen suspended in water
 W = the weight of specimen in air including the moisture in its open pores.

3. Cold crushing strength
4. Refractoriness under load
5. Refractoriness under load, thermal expansion and thermal conductivity
6. 1710 deg Celsius
7. Thermal expansion.
8. It is the measure of resistance offered by a material to the chipping off the particles from it. Erosion takes place when molten metal or gas carry dust and slag particles. When these slag and dust particles strikes against refractory lining it results in chipping off particles from it. Splashing of slag erodes the refractory walls whereas slag particles carried along by flame or gases erode the arches and bends of the structure in particular.
9. As the porosity increases the thermal conductivity decreases. The refractories having air entrapped in their pores behave like insulator.

MODULE I
UNIT IV

CERAMIC REFRACTORY TECHNOLOGY I

**INTRODUCTION TO REFRACTORIES, CLASSIFICATION,
PROPERTIES, OCCURENCE OF RAW MATERIALS**

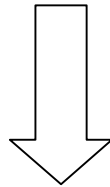

OCCURENCES OF RAW MATERIALS

CONTENT

PAGE

 OBJECTIVES

1/4/3

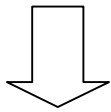

INPUT : OCURANCES OFV RAW MATERIALS

1/4/4

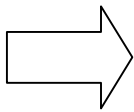

PRACTICE TASK

1/4/6



FEEDBACK TO PRACTICE TASK

1/4/7

UNIT IV Occurrences of raw materials

OBJECTIVES

GENERAL OBJECTIVE: Know the occurrence of various raw materials of refractories and manufacturing units of refractories in India

SPECIFIC OBJECTIVES: At the end of this unit, you will be able to

1. Name various places of occurrence of raw materials.
2. Name various manufacturing units in India.

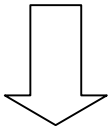

INPUT

1.3 Occurrences of raw materials and manufacturing units in India

In last unit you have studied properties of refractories. Before proceeding further, it is important to know the places of occurrences of various raw materials used in India. The raw materials used in refractory can be divided into acidic (e.g. silica and siliceous), basic (e.g. magnesite and lime) and neutral (e.g. chromite). The main raw materials include fireclays, kaolins, silica materials (sandstone, quartzite, ganister, firestone and diatomaceous earth), alumina raw materials etc and corundum, sillimanite, kyanite, andalucite, magnesite, chromite, graphite and carbon material, zircon refractory raw material. Can you name places where raw materials are found in India? Do you know scope for refractory engineer in India?

1.3.1 Places of occurrences of raw materials in India

The occurrence of raw materials as per their names and places of occurrences are given in table no: 4.1

Raw Material	Places of Occurrences
Fireclay	In the coal fields of Jharkhand, West- Bengal, Madhya Pradesh, Orissa , Andhra Pradesh.
Sillimanite	Khasi hills in Assam, near Pipra village in Madhya Pradesh, near the village Pohra in the Bhandara district of Maharashtra, as beach sand in Travancore in Kerala State.
Kyanite ($Al_2O_3 \cdot SiO_2$)	Chhota Nagpur division of Jharkhand
Silica	In the form of quartzite deposits in Bihar sharif and Monghyr districts of Bihar, Lotapahar and Brajmada in Orissa.
Magnesite	Chalk Hills in Salem district and Dodkanya in Mysore state, Idar in Gujrat, Doongarpur in Rajasthan, Almora district of U.P.
Chromite	Mysore, Haasan Kadur, Chitradurg and Shimoga in Karnataka, Salem district of Tamilnadu, Singhbhum of Jharkhand, Ratangiri in Maharashtra and Ladakh in J&K.
Zirconia	In the form of zirconium minerals, which occurred as beach sand in Kerala
Carbon and Graphite	Orrisa, Bihar and Karnataka

1.3.2 Manufacturing units of Refractories in India

The various manufacturing units in India are as follows

1. Tata Refractories Limited, Belapur, Orissa.
2. Bharat Refractories Limited, Marar, Ramgarh, Jharkhand.
3. Valley Refractories Limited, Chirkunda, Dhanbad, Jharkhand
4. Miathan ceramics Limited, Chirkunda, Dhanbad, Jharkhand.
5. Hind Gulf Refractories, Gandhinagar, Kutch, Gujrat.
6. Prajapati Refractories, Thangadh.
7. Carborrundum Universal Limited, Ranipet, Tamilnadu.
8. Monolithic Refractories, Isanpur, Ahmadabad.
9. Vision Refractories Private Limited, Mumbai.
10. Thermo Technologies Private Limited, Delhi.
11. Alwar Refractories Private Limited, Alwar , Rajasthan
12. OCL india Limited, New Delhi
13. PINC Group, Kilpauk, Chennai, Tamil Nadu.
14. Grind well Norton limited, Devanhalli Road, Bangalore, Karnatka.
15. Reliable Refractories Private Limited, Bhilwara, Rajasthan.

These are names of major Industries. Most of the industries are located near the places of occurrences of their major raw materials.

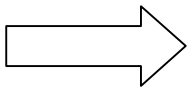

Now do the following practice task

1. Match the following raw materials against their places of occurrence.

Raw material	Place
1. Fireclay	A. Khasi hills in Assam
2. Sillimanite	B. Ratangiri in Maharashtra
3. Kyanite	C. Idar in Gujrat
4. Magnesite	D. Monghyr distructs of Bihar
	E. Chhota Nagpur division of Jharkhand
	F. In the coal fields of Jharkhand

2 Name any two manufacturing units of refractories in India.

NOW CHECK YOUR RESPONSE

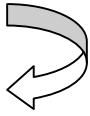

FEEDBACK TO THE PRACTICE TASK

1. 1-C, 2-A, 3-F, 4-D
2. (i) Tata Refractories Limited, Belapur, Orissa
(ii) Bharat Refractories Limited, Marar, Ramgarh, Jharkhand.

Self Learning Module

Testing of Refractories

MODULE II

CERAMIC REFRACTORY TECHNOLOGY I

TESTING OF REFRACTORIES

Developed By Ashwani Kumar student of M.Tech Engg. Education as a part of teaching methodologies for 4th semester students of Ceramics Technology in the subject Ceramic Refractory Technology - I

CONTENT	PAGE
Purpose of module	2/0/1
Objectives of Module	2/0/1
Content of module	2/0/2
How to use this module	2/0/3
References	2/0/4

PURPOSE OF THE MODULE

After going through module-I, you must have basic understanding of Refractories. The purpose of this module is to outline various testing procedures of Refractories..

OBJECTIVES OF MODULE

By the end of the module you will be able to

1. Enlist various tests of Refractories.
2. Understand testing procedures of Refractories.

CONTENTS OF MODULE

This module has been divided into units, each of which is presented in separate sections.
The titles of these units are as follows

UNIT V A TESTING OF REFRACTORIES

UNIT V B TESTING OF REFRACATORIES

HOW TO USE THIS MODULE

If you want to gain maximum benefit from this module, you will have to follow instructions carefully. To help you to use the module properly, the key points you need to be familiar with are summarized below.

1. The module is divided into six units.
2. Pages are numbered according to the module and units. For example

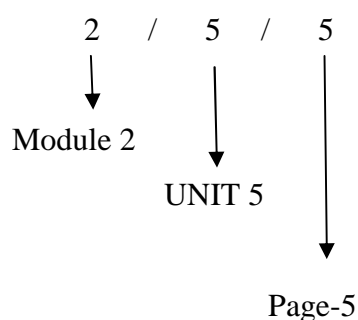

3. The topics in the module are numbered using points. These points indicate the unit number, topic and sub-topic. For example 1.2.3 indicates first unit, second topic or section and third sub topic or sub section.
4. After the first page of every unit, you will find the content of that unit.
5. On the next page of each unit, you will find the general and specific objectives for that unit. Read them carefully.
6. Each unit has sequence of activities

 **OBJECTIVES:** These are general and specific objectives for that unit.

 **INPUT:** This contains new information for you to learn

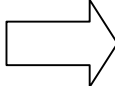
 **PRACTICE TASK:** Here you are presented some tasks based on input which you must complete.

 **FEEDBACK TO PRACTICE TASK :** This contains the correct answers to the practice task.

7. You must work through each unit in the sequence in which it is presented. After going through the input, do the practice task. Look at the feedback to the practice task only after you have completed the practice task.
8. Read your own.
9. Begin working on the next unit in the module only after you have completed the previous unit and you are confident that you have achieved the objectives of unit.

REFERENCES

You may wish to follow up some of the things that you will learn in this module. To help you to do this a list of useful references is given below:

1. CHESTI, R. Refractories Manufacturing, Properties and Applications,
Prentice Hall of India Private Limited, New-Delhi (1986)
2. KHANNA, O.P. Elements of fuels, furnaces and refractories,
Khanna Publishers, New delhi (2002)
3. CHESTERS, J.H Refractories, Production and Properties,
Iron and steel institutes, London(1973)
4. NANDI, D.N. Handbook on Refractories,
Tata McGraw-Hill Publishing Company, New-Delhi(1991)
5. NORTON, F.H. Refractories, McGraw Hills company, New York (1980)

MODULE II
UNIT V A

CERAMIC REFRACTORY TECHNOLOGY I

TESTING OF REFRACTORIES

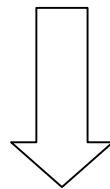

TESTING PROCEDURES OF REFRACTORIES

CONTENT

PAGE

 OBJECTIVES

2/5/3

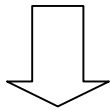

INPUT : OCURANCES OFV RAW MATERIALS

2/5/4

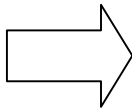

PRACTICE TASK

2/5/14



FEEDBACK TO PRACTICE TASK

2/5/15

UNIT V A Testing of Refractories

OBJECTIVES

GENERAL OBJECTIVE: Understand the methods of testing refractories.

SPECIFIC OBJECTIVES: At the end of this unit, you will be able to

1. Name various tests of refractories.
2. Describe method of testing refractoriness.
3. Describe steps involved in testing Refractoriness under load
4. Describe method of testing spalling resistance
5. Write procedure of testing resistance to chemical attack
6. Describe method of testing permeability.

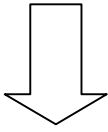

INPUT

2.1 Testing of various properties of refractories.

In unit number three you have studied various properties of refractories. To assess these properties you need to test these refractories. Inspection and testing of refractories is important to ensure suitability of a refractory product for an end use. Not only this, testing also help refractory engineer to control process of manufacturing. You must note that results of tests are not of much importance. Their interpretation is important. This is so because no definite correlation between results and their performance is found. This in turn guarantee minimum quality variations and ensure conformity of the product to specific consumer specification. Following are methods used for testing various properties of refractories:-

- 2.5.1 Pyrometric cone equivalent(PCE)
- 2.5.2 Refractoriness under load(RUL)
- 2.5.3 Spalling resistance
- 2.5.4 Resistance to chemical attack
- 2.5.5 Permeability
- 2.5.6 Apparent porosity
- 2.5.7 True specific gravity and true density
- 2.5.8 Bulk density
- 2.5.9 Cold crushing strength(CCS)
- 2.5.10 Modulus of rupture(MOR)
- 2.5.11 Permanent linear change(PLC)

2.5.1 Pyrometric cone equivalent (PCE)

This test is conducted to determine the softening temperature of refractories to help in selection of refractories to suit specific working temperatures. In this test softening characteristics of cones are compared with standard pyrometric cone in a furnace having neutral or oxidizing atmosphere.

Procedure for testing of refractoriness is as follows:

- i. Take one kg of refractory to be tested.
- ii. Crush in roll or jaw crushers to a size 5mm.
- iii. Ground in a porcelain or agate and passed through 20 micron I.S. sieve.
- iv. Pass ground material through magnetic separator to remove iron particles.
- v. Mix the material thoroughly with required amount of water and alkali free dextrin or glue.
- vi. Make the cones with the help of mould of the shape of a tetrahedron with 8mm sides on the base and 25mm height.
- vii. Sintered the cones at 1000 deg Celsius for easy handling.
- viii. Arrange the test cones and the standard Pyrometric cones of known softening temperature on plaque with the help of some bonding material as shown in figure 5.1. This material should not react with the cones and reduce their fusibility. Standard cones are chosen keeping in view the anticipated fusion temperature of the test cones
- ix. Fix each cone on the plaque forming an angle of 82 degree with the horizontal.
- x. Keep the plaque in a suitable furnace either gas fired or electrically heated as shown in figure 5.2. The flame should not directly strike the cones and furnace atmosphere should be oxidizing or neutral.

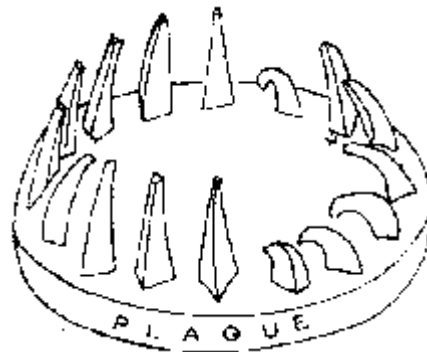

Figure 5.1 : Arrangement of cones on a plaque

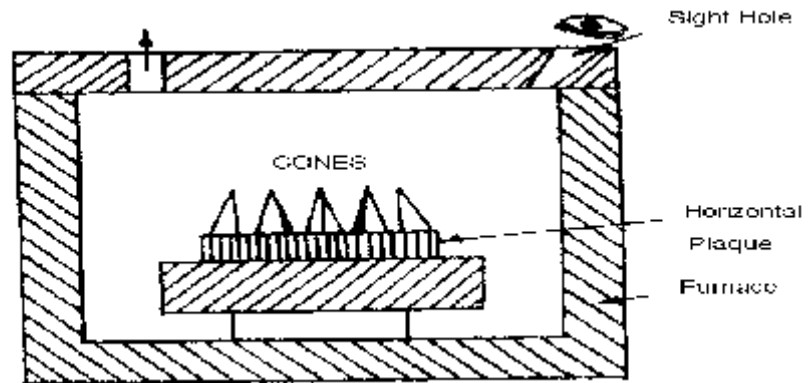

Figure 5.2 : Fusion Point Furnace

(xi) Maintain rate heating should as per schedule given in table number 5.2

Table 5.2 : Heating Schedule

Room Temp. to ASTM Cone No.	Time interval (Min.)	Cumulative time (Min.)	End Point (°C)
20	45	45	1621
23	16	61	1640
26	7	68	1646
27	7	75	1659
29	8	83	1665
31	10	93	1683
31.5	6	99	1717
32	7	106	1724
32.5	3	109	1743
33	7	116	1763
34	9	125	1785
35	9	134	1804
36	7	147	1820
37	7	148	1835

(xii) Observe the softening of cones through a peep hole. It is indicated by top bending over of the cone and tip of the cone touching the plaque surface as shown in figure 5.3

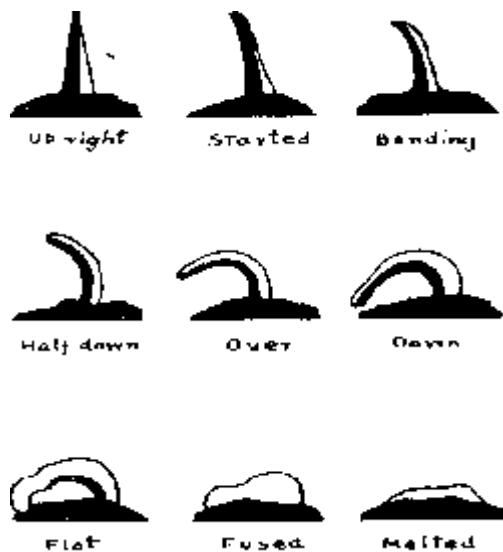

Figure 5.3 Progressive bending of cones in fusion point furnace (P.C.E.) furnace

(xiii) Record the softening point of the standard Pyrometric cone which most nearly corresponds in time of softening with the test cone as the P.C.E. of the test cone. If the test cone softens in between two standard cones than the P.C.E. of the test cone is taken as the mean of the two cones.

Sometime instead of bonding the cones with the plaque self supporting cones can also be used as shown in figure 5.4



Figure 5.4 Self Supporting Cones prior to firing (top) and after (bottom)

2.5.2 Refractoriness under load (RUL)

RUL is a measure of a resistance of a refractory product to deformation when it is subjected to combined effect of load, rising temperature and time. It is the softening temperature of a refractory under loaded conditions corresponding to breaking of refractory brick. Following procedure is used for testing RUL

- i. Take a specimen of refractory whose RUL is to be determined.
- ii. Obtain a cylindrical shape having diameter 50 ± 0.5 mm and height 50 ± 0.5 mm by cutting, boring and grinding the central portion of refractory being tested. One of the face of specimen should be original faces of the refractory sample taken forming one of the faces of the finished test specimen.
- iii. Check that the refractory specimen must be free from cracks and other macro defects.
- iv. Heat the sample in an electric furnace consisting of a refractory tube of 100 to 120 mm internal diameter, 120 to 150 mm outer diameter and about 500 mm length. This tube can be of corundum, magnesite or mullite as shown in figure 5.5
- v. Ensure to keep central 100 to 120 mm length of tube is placed in the hottest zone of the furnace.
- vi. Place the sample in the central portion between carbon or mullite rods with about 5mm thick carbon plates in between sample and rods.
- vii. Apply the load of 2kgf/cm^2 is applied with the help of rods.
- viii. Heat the furnace at the rate of 15°C per minute up to 1000°C and at the rate of 8°C above 1000°C .
- ix. Plot the change in height is against the time on rectangular co-ordinates. As the temperature is raised at approximately constant rate and change in height is plotted against the time, the chart will give temperature deformation curve.
- x. Measure the temperature with the help of an optical pyrometer. It is sighted obliquely through a 20mm (max) ID radial tube or adjusted upon the bottom of refractory tube closed at its bottom and suspended in the furnace at the beginning of the test at about middle of the specimen. This is tightly closed by total reflecting prism interposed for giving allowance for diminution of intensity. There should not be more than 30°C variation in horizontal plane.

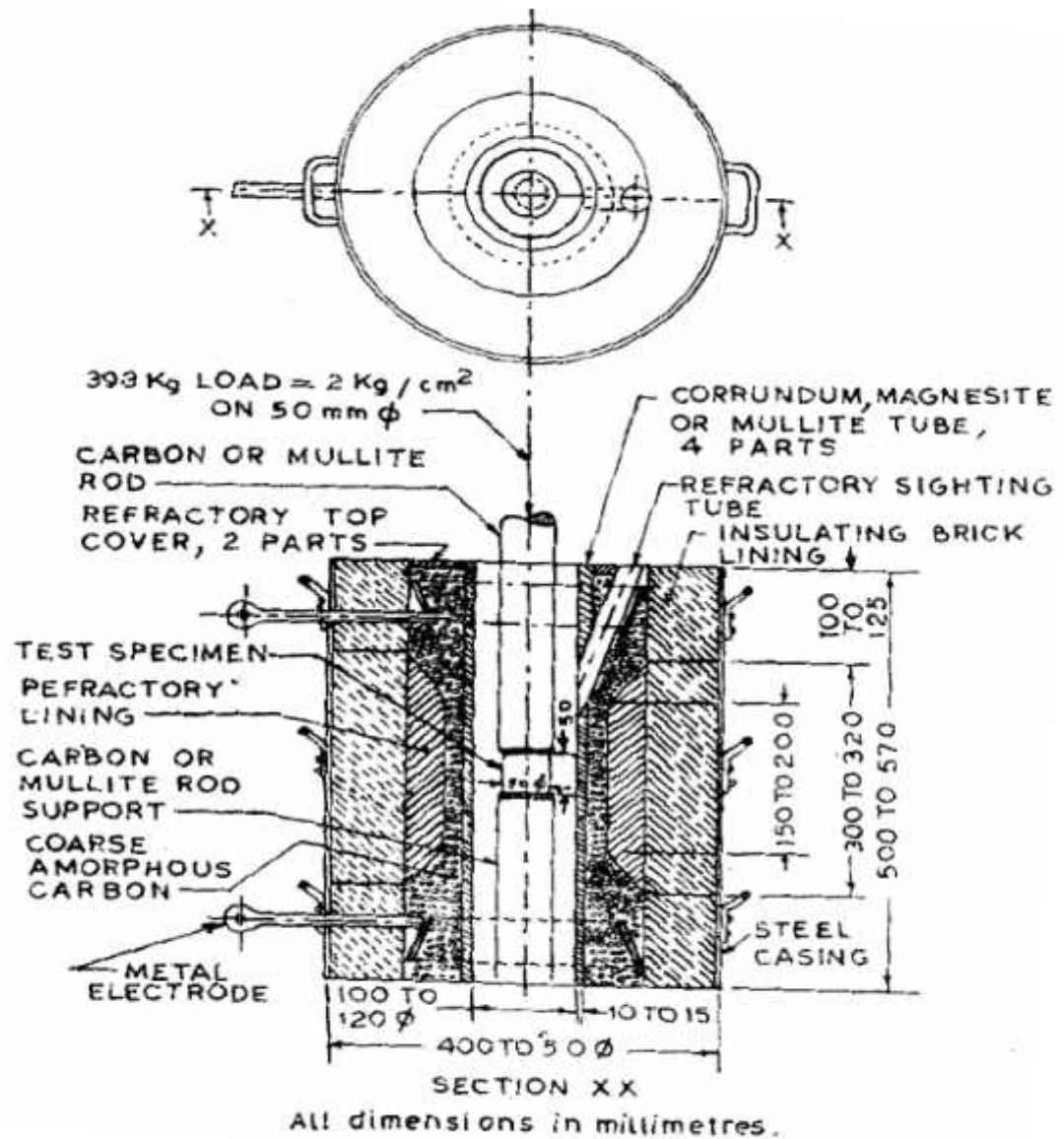

Figure 5.5 RUL Furnace

(Reproduced from Refractories Manufacturing, Properties and Applications, Prentice Hall of India Private Limited, New-Delhi ,(1986)

(xi) Change in the height of the specimen on heating is plotted against temperature on 10:1 scale to represent temperature deformation curve for the test. The typical curve for some of the refractories is shown in figure 5.6

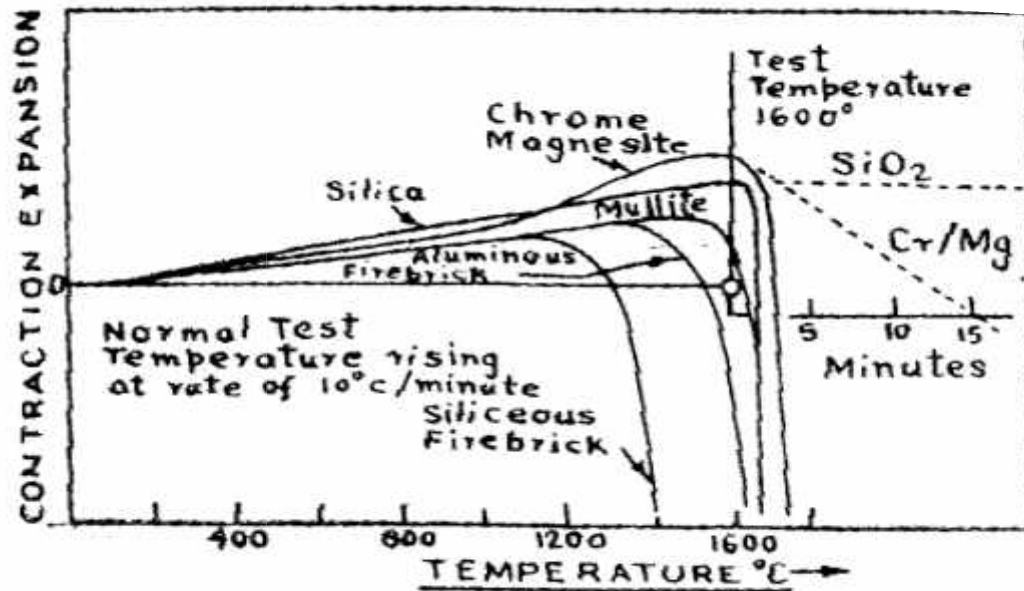

Figure 5.6 Typical RUL curve of some of refractories.

(xii) From the plotted curve, note the temperature (T_a) corresponding to the point at which the curve has dropped 3mm below its highest point(denoted by bend of curve downwards with respect to horizontal tangent).The temperature (T_c) cooresponding to the point at which the height of the tse specimen has decreased by 20mm from its original height is also noted. The temperature (T_b) at which premature breaking of the test specimen, without its actual softening takes place denotes the breking ponit of the test specimen.

1.5.3 Spalling resistance

Spalling resistance is determined by one of the two standards methods:-

1.5.3.1 Panel Test

1.5.3.2 Small prism test

1.5.3.1 Panel Test

Procedure for determination of spalling resistance by Panel test method

- i. Cut 12 to 14 test specimens from original refractories by cutting wheel. The size of specimen should be of 65-70mm thick, 230 mm long and 113mm wide. If size of original brick is 230mm in length then take original shapes for testing.
- ii. Label with ceramic paint on the inner face which is not exposed to heating.
- iii. Each specimen is then dried at 105 °C and weighed.
- iv. Then lay test specimens in the panel frame by kaolin or any other suitable material having PCE value not less than that of refractory specimen. Selected Material should not react with refractory specimens.
- v. Ensure Joints of specimens less than 2mm thick.
- vi. Back the test panels are with suitable insulation to allow heat loss of approximately 605 kcal/m²/hr (°C/m) under operating conditions. Its mean temperature should be about 700 °C.
- vii. Preheat the panel assembly gas or oil fired furnace. Maintain face temperature at 1600 °C (average) for 24 hrs. Raise the temperature of preheating i.e. up to 1600 °C in 5 to 8 hrs.
- viii. Record the condition of samples after preheating and take photograph for record.
- ix. Remove the insulation from panel and transfer the samples in spalling furnace with the help of track or trolley.
- x. Heat the samples in spalling furnace at 1400 °C. Maintain the rate of heating in such a way that this temperature is attained in 3 hrs.
- xi. Change the position of panels at 1000 °C, 1200 °C and 1300 °C for uniform heating. Heat the specimens for 10 min. at 1400 °C.
- xii. Cool the panel cooled for 10 min. with the help of blast of air-water mist. This is delivered through vertical manifold having aperture of size 90mm × 600mm. Admit the air at the rate of 40m³ per minute. Admit the water at rate of 11 litres during first 8 minutes of cooling. No water is admitted during last 2 minutes. The cooling unit is provided to and fro motion (about 125 times in one minute) over the entire surface of panel by external means.
- xiii. Subject the samples are subjected to such 12 heating and cooling cycles.
- xiv. Switch off the furnace
- xv. Subject the panels to another two cooling cycles without water mist

- xvi. Then cool the specimen overnight after spacing the panel 25mm face to face
- xvii. Carefully remove the refractories samples after 24 hrs from the panel .
- xviii. Weigh all the samples and rearrange in original order for comparison with photographs. The average loss of weight of panel gives the indication of the extent of spalling resistance.

1.5.3.2 Small prism test:- This is another method to determine spalling resistance. The procedure is described below.

Procedure for determination of spalling resistance by small prism test method

- i. Cut three specimens from refractories(of standard shape) under test. Ground the specimens in shape of prism of size 50mm side and 75 mm height. In case of non-standard shapes (sleeves, nozzles or other pouring type refractories), the test specimens are cut in form of ring of height 50mm.
- ii. Dry these specimens to a constant weight.
- iii. Then place the specimens in cold muffle or semi-muffle type furnace. Heat the furnace at uniform rate to attain temperature of 450 in 3 hrs in case of silica refractories. In case of fireclay, siliceous or basic refractories heat the specimens to attain 1000 in three hours.
- iv. Heat the specimens for ten minutes.
- v. Remove the specimens from furnace with the help of pre-warmed pair of tongs.
- vi. Place these specimens on a brick floor for 10 minutes for cooling. The room should be free from draughts.
- vii. Observe the samples for any crack.
- viii. Again reheat the specimens for 10 minutes and cool for another 10 minutes.
- ix. Again observe the specimens for any cracks.
- x. Repeat the steps eighth and ninth till cracks are appeared. Note the cycle, in which crack appear. Number of such heating and cooling cycles is the measure of spalling resistance

2.5.4. Resistance to chemical attack

Chemical attack on refractories takes place due to slags, gases like carbon monoxide and glasses etc. at the high working temperature.

2.5.4.1 Resistance to slag attack:-

The resistance to slag attack can be determined by one of the following methods:-

Running slag test:- In this test specimen refractories in the form of single brick or column of bricks are heated to a uniform temperature. The temperature is near to the temperature at which refractory is finally to be used. Then the powdered slag dropped regularly on top of refractory. The slag run from here in groove downward provided for the purpose. At the close of test the depth of groove is again determined. The enlargement of groove determines the resistance of the refractory to slag attack. This test gives excellent results. However, this test can not be used to determine quantitative results.

Spray test:- In this test refractory sample is maintained at uniform temperature. The powdered slag is then sprayed on heated refractory surface with the help of revolving burner.

The slag powder is thus impinged uniformly and under similar temperature and other working conditions over the entire surface of the refractory under test. The decrease in thickness gives the slag resistance.

Molten bath slag test:- This is another test to determine the slag resistance. In this test the refractory to be tested is kept in bath of molten slag. The slag is stirred to expose the refractory surface to fresh slag. The decrease in dimension of brick gives the measure of slag resistance.

2.5.4.2 Resistance to carbon monoxide attack:-

Carbon monoxide have disintegration effect on refractories. This effect depends on amount of ferric oxide present in refractories. The carbon monoxide gas is generated by reaction of formic and sulphuric acid or by the reaction of charcoal at 1000 . You must purify the nitrogen and carbon monoxide for carbon, oxygen and water vapors. Measure

the flow rate carbon mono oxide with the help of manometer and a flow meter in the circuit.

Procedure for determination of resistance to carbon mono oxide attack

- i. Cut two specimens cut in cylindrical shapes of 50 mm length and not less than 30 mm diameter. One specimen is cut from interior of refractories and other from exterior of other refractory shape. You can cut specimens in prismatic or rectangular shape.
- ii. Place the test specimens in wire wound electrical furnace.
- iii. Purge the furnace with nitrogen.
- iv. Heat the furnace at 450 and pass purified carbon monoxide through the furnace at the rate of 2 litres per second.
- v. Carry out the test for 100 hrs or when refractory gets disintegrated if it occurs earlier. Examine the test pieces regularly for discoloration, carbon deposition and disintegration that may take place during the course of test.
- vi. Record the observations for each of the two specimens.
- vii. Maintain the test temperature between 450 to 500 .
- viii. Note the time at which disintegration or deposition of carbon monoxide takes place. This is taken as measure of resistance of refractory to carbon monoxide.

1.5.5 Permeability:-

It is a measure of rate at which a fluid flows through a porous body. It is denoted by the volume of gas or air in cc that passes through one centimeter refractory cube at a unit pressure difference(gm/cm sq.) per minute. Schematic representation of the permeability determination apparatus is shown in figure 5.7

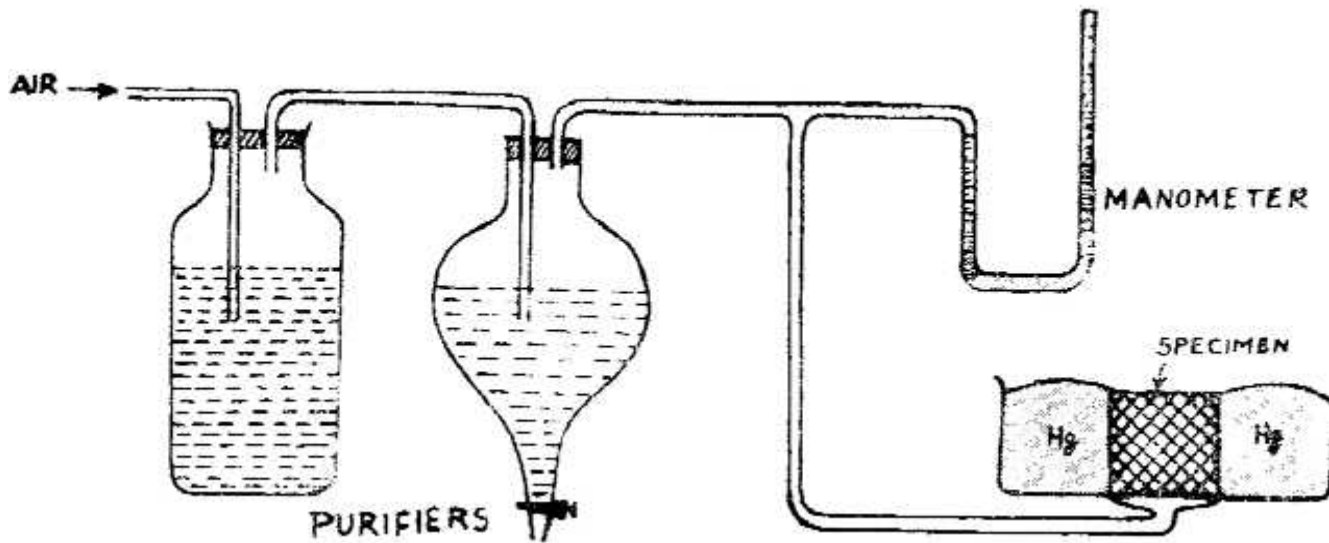

Figure 5.7: Permeability apparatus

Pass the purified air through a cubic refractory sample of known surface area and thickness. Fix the sample in mercury seal. The pressure difference is measured by manometer. Note the Volume of air passed in a given time. Then Permeability of refractory sample can be calculated by using the following formula:-

$$\text{Permeability} = \frac{V.H.}{A.t.p}$$

Where V= Volume of air passed through specimen(cc)

H= thickness of sample(cm)

A= cross sectional area of the sample(sq.cm)

t= time for which air is passed through the sample(min)

p= pressure difference across the two surfaces of the sample(gm/sq.cm)

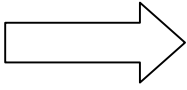

Now do the following practice task

1. Write the dimensions of the cones used in refractoriness testing.
2. What is P.C.E.
- 3 Write refractoriness value of silica brick.
4. Define RUL.
5. Write the size of refractory tube of RUL furnace?
6. Name the two tests used to measure resistance to slag attack.
7. Name the tests used to determine spalling resistance
- 8 .Why sample is sealed in mercury in permeability test.

NOW CHECK YOUR RESPONSE

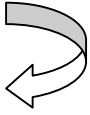

FEEDBACK TO THE PRACTICE TASK

1. Tetrahedron shape with base side 8mm, Height 25mm
2. Pyrometric cone equivalent
3. 1710 degree Celsius
4. RUL means refractoriness under load .It is a measure of a resistance of a refractory product to deformation when it is subjected to combined effect of load, heat and time.
5. Internal diameter = 100 to 120 mm,
Outer diameter =120 to 150 mm
Length = 500 mm
6. (i) Running slag test
(ii) Spray test
7. (i) Panel Test (ii) Small prism test
8. Since mercury is not wetting and also it make the sides completely air tight so that fluid can pass through only opposite faces

2/5/17



MODULE II
UNIT V B

CERAMIC REFRACTORY TECHNOLOGY I

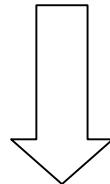
TESTING OF REFRACTORIES

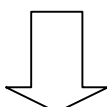
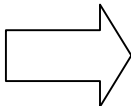

TESTING PROCEDURES OF REFRACTORIES

CONTENT	PAGE
 OBJECTIVES	2/5/19
 INPUT : OCURANCES OFV RAW MATERIALS	2/5/20
 PRACTICE TASK	2/5/32
 FEEDBACK TO PRACTICE TASK	2/5/33

UNIT V B Testing of Refractories

OBJECTIVES

GENERAL OBJECTIVE: Understand the methods of testing refractories.

SPECIFIC OBJECTIVES: At the end of this unit, you will be able to

1. Describe steps involved in testing apparent porosity
2. Describe method of testing bulk density
3. Describe method of testing true specific gravity and true density.
4. Describe method of testing modulus of rupture.
5. Describe method of testing permanent linear change.

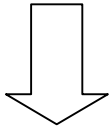

INPUT

2.5.6 Apparent porosity

You can determine the apparent porosity by any of the two methods

2.5.6.1 Boiling point method

This test takes the following procedural steps

- i. Cut the test specimens of size 6.5cm×6.5cm×4cm with the help of cutting wheel. The sample should be cut from interior of the brick
- ii. Remove the any loose adhering particles.
- iii. Dry the sample in oven at 110 to a constant weight. Note it as 'D'.
- iv. Suspend dry sample in distilled water. The sample should not touch sides or bottom of the vessel.
- v. Boil the specimen in suspended condition for two hrs and the cool it.
- vi. Take its weight in suspended condition and note it as 'S'.
- vii. Remove the specimen from water.
- viii. Wipe of extra water with blotting paper
- ix. Weigh in air and note it as 'W'
- x. Then calculate apparent porosity (P) by using following formula: -

$$P = \frac{W-D}{W-S} \times 100$$

Where W-D= actual volume of open pores of the specimen (CC)

W-S= external volume of the specimen (CC)

2.5.6.2 Evacuation method

You can determine the apparent porosity by evacuation method also.

Following are the steps to carry out the test

- i. Cut the test specimens of size 6.5cm×6.5cm×4cm with the help of cutting wheel.
- ii. Cut the sample from interior of the brick and remove any loose adhering particles.
- iii. Dry the sample in oven at 110 to a constant weight. Note this weight as dry weight 'D'.
- iv. Place the dried sample in empty vacuum desiccator.
- v. Evacuate the desiccator to a pressure less than 25 mm of Hg.
- vi. Then admit the immersion liquid (water or fraction of liquid paraffin boiling above 200).
- vii. Place the sample in such condition for 2-3 hrs under reduced pressure.
- viii. Allow the air to enter the desiccator.
- ix. Take its weight in suspended condition with the help of sling thread. Note it as suspended weight 'S'
- x. Remove the specimen with the help of sling thread slowly. Wipe off extra water with blotting paper
- xi. Weigh in air and note it as saturated weight 'W'.
- xii. Then calculate apparent porosity (P) by using following formula: -

$$P = \frac{W-D}{W-S} \times 100$$

Where W-D= actual volume of open pores of the specimen (CC)

W-S= external volume of the specimen (CC)

2.5.7 Bulk Density

Bulk density can be measured by either of two methods

2.5.7.1. Direct measurement method

2.5.7.2 Direct volume measurement method

2.5.7.1 Direct measurement method:-

This method is used to determine the bulk density of regular shape refractories. First determine the volume of refractories by measuring its dimensions directly. Then take its weight. The bulk density is then determined from the formula:-

$$D_B = \frac{W}{V} \text{ (g/cc)}$$

Where W = weight of specimen in grams

V = volume of specimen in cc.

2.5.7.2 Direct volume measurement method:-

This method is used to determine the bulk density of those refractories which are having intricate shapes. In this method value of dry weight (D), suspended weight (S) and saturated weight (W) is determined. The same procedure is used, which was used for apparent porosity determination. Then calculate the bulk density by using the following formula:-

$$D_B = \frac{D}{W-S} \text{ (g/cc)}$$

Where D = Dry weight of sample (in gram)

w-s = external volume of specimen (in cc)

2.5.8 True Specific Gravity and True density

This test is conducted when materials does not dissolve in or attacked by water.

Procedure for determination of True specific gravity and true density.

- i. Take two test specimens of refractory to be tested
- ii. Cut two test pieces of walnut size from interior of refractory
- iii. Crush the pieces to a size not exceeding 3 mm.
- iv. Mix and reduce the crushed sample to 50 gram by coning and quartering
- v. In case of pre ground material, draw 500 gram of representative sample and reduce to 50 gram by coning and quartering.

- vi. Grind cone material in agate so that it pass through 149 micron IS sieve.
- vii. Remove magnetic fractions with the help of magnetic separator introduced during crushing and grinding.
- viii. Dry the material to constant weight at 105-110 °C
- ix. Take 8-12 gram of sample and place in glass stoppered weighing bottle.
- x. Take a pycnometer dry it at 105-110 °C, cool in dessicator and note down its weight as 'Wp'
- xi. Fiil the pycnometer with distilled water at room temperature.
- xii. Place the stopper
- xiii. Wipe the extra water outside and note down its weight as 'W₁'
- xiv. Empty the pycnometer, dry it and fill with material sample from weighing bottle. Weight it and note it as 'W' with stopper in position.
- xv. Fill half of pycnometer with distilled water and boil it for 10-15 minutes. This is done to avoid loss of sample due to popping.
- xvi. Then fill the remaining part of pycnometer with distilled water and cool to room temperature in water bath.
- xvii. Place th stopper in position and wipe of extra water.
- xviii. Weigh the pycnometer and note its weight as 'W₂'
- xix. Calculate specific gravity and true density by using following formula

$$\begin{aligned} \text{True Specific Gravity} &= \frac{\text{weight of sample}}{\text{weight of equal volume of water}} \\ &= \frac{W - W_p}{W - W_p - (W_2 - W_1)} \end{aligned}$$

$$\begin{aligned} \text{True density} &= \text{True specific gravity} \times (d_w - d_a) \text{ g/cc} \\ &= \frac{(W - W_p)(d_w - d_a)}{W - W_p - (W_2 - W_1)} \text{ g/cc} \end{aligned}$$

Where d_w and d_a are densities of water and air repectively at the temperature at which test is conducted.

2.5.9 Cold crushing strength:-

Do you know importance of this test ? This is so because refractories bricks are subjected to load bearing services. CCS is determined by standard hydraulic or mechanical compression testing machine shown in figure 5.8 .Various steps involved are

- (i) Cut the test specimens from refractory shapes preserving the original surface as far as possible. Size should be kept equivalent to size of 230mm standard brick. If smaller and other special refractory shapes the test specimens the smaller size are used. In this case sample size can be cube with side of 75mm are used.
- (ii) Keep the specimens between two rams (bearing block having plane surface of size equal to or more than that of specimen) of machine. In between ram and specimen 5mm thick asbestos fibre board or cardboards are kept. As shown in figure 5.8.
- (iii) Switch on the machine to move the rams. The machine indicates the pressure in terms of tonnage on pressure gauge. The pressure will be shown for every moment.
- (iv) Note down the pressure when the brick fails. At this point indicator returned back to zero. This value of machine gives the value of CCS. At the time of failure, cracks will appear on the surface of sample.

The assembly used in test is shown in figure 5.8:-

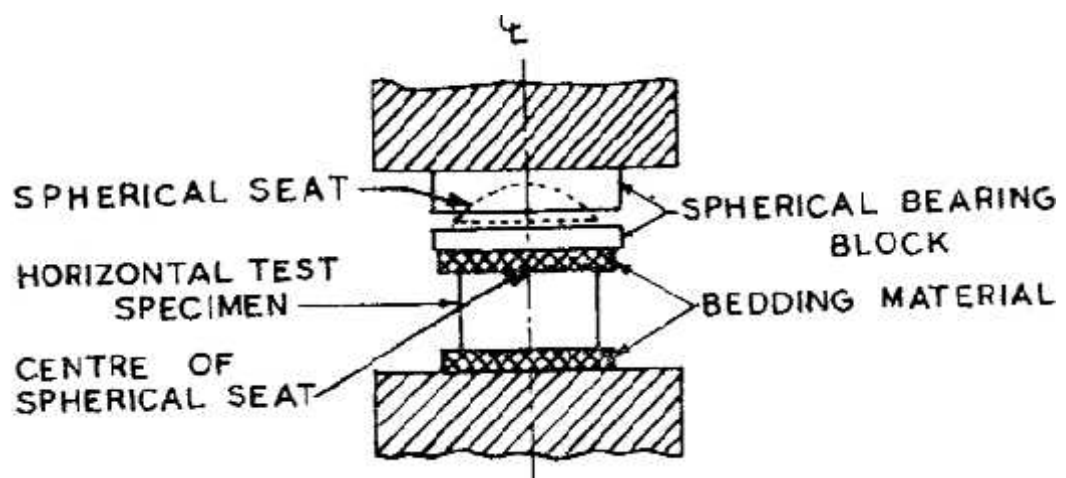

Figure 5.8 Crushing test assembly

2.5.10 Permeability:-

It is the measure of the rate at which the fluid flows through a porous body. It is denoted by the volume of gas or air in cc that passes through one centimeter refractory cube at a unit pressure difference(g/cm²). The schematic representation of the permeability apparatus is shown in figure 5.9

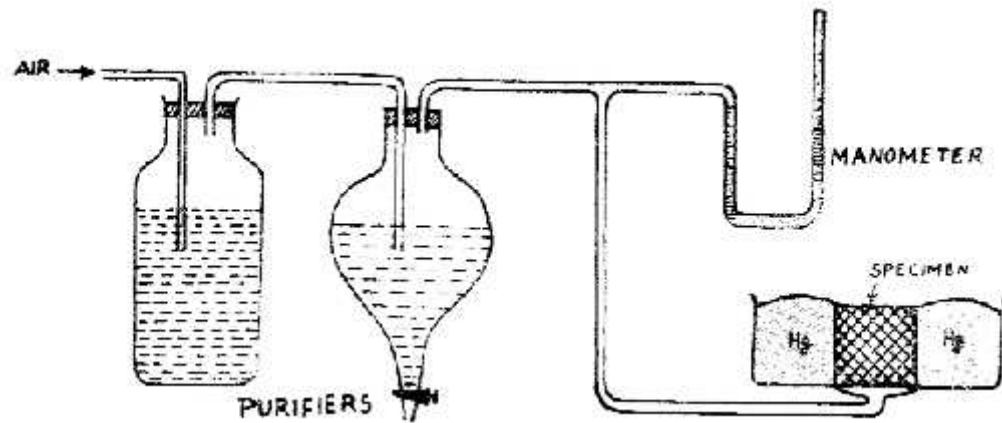

Figure 5.9: Permeability apparatus

In this test pass the purified air through a refractory sample of known surface area and thickness. The sample is fixed in a holder with a mercury seal. The pressure difference is measured by a manometer. Note the volume of air passed in a given time. Permeability of refractory sample is calculated by using following formula:-

$$\text{Permeability} = \frac{V.H.}{A.t.p}$$

Where V= volume of air passed through specimen (cc)

H= thickness of specimen(cm)

A = cross sectional area of the specimen(sq. cm)

t = time for which air is passed through specimen(min.)

p= pressure difference across the two surfaces of the sample(g/sq.cm)

2.5.11 Modulus of rupture test (MOR)

Failure of refractory brick generally takes place due to bending moments. In practice failure of bricks due to crushing rarely takes place. MOR test is used to determine resistance offered by brick to bending moments. This test is performed with the help of standard mechanical or hydraulic compression machine as shown below:-

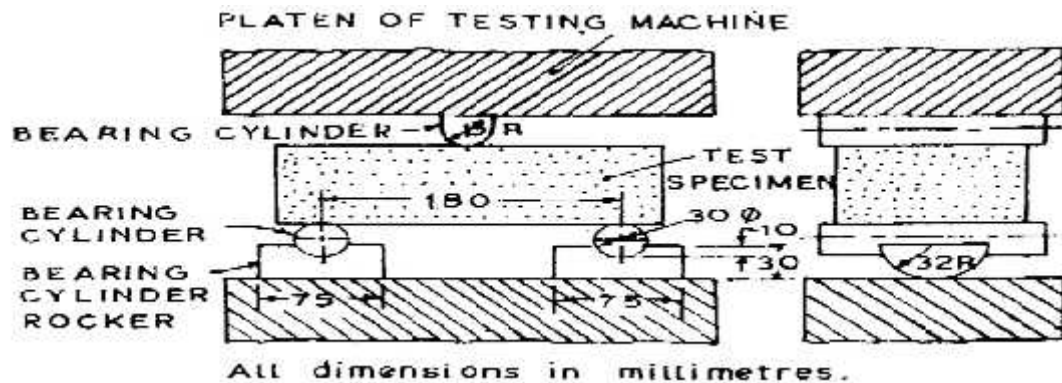

Figure 5.10: MOR machine

To perform this test cut the test specimen of size 22cm×11.3 cm×6.5cm or 7.5cm. The specimen is cut from desired refractory shape. Place the specimen on the bearing edges of the machine. These edges are positioned 18 cm apart. Apply the load at the middle of the specimen uniformly. The rate should be 10kgf per minute(±10%) in case of mechanical pressing machine. Load should be applied without any jerk. Note the load (W) at which the specimen fails. Then use following relation to calculate MOR.

$$\text{M.O.R.} = \frac{3WL}{2bt^2} \text{ kgf/sq. cm}$$

Where L = the distance between bearing edges(cm)

b= width of specimen(cm)

t= thickness of specimen(cm)

2.5.12 Permanent linear change (PLC)

Do you know why permanent linear change is important to determine? Because it indicates the volume stability i.e, expansion or shrinkage, of the refractories takes place during service(use as lining). It also indicates reversible thermal expansion i.e., the

material expands on heating and contract on cooling due to phase transformation during use. The PLC and reversible thermal expansion value is used in designing refractory lining for providing expansion joints. PLC is can be determined by two methods.

2.5.12.1 Permanent linear cahange on reheating(PLCR) :-

This test is carried out in the laboratry furnace. The sample is heated to particular temperature for particular time. This temperature and time is different for dirfferent refractory materials. The test results can be reported in two ways

Linear change:- The PLCR is expressed as percentage of increase/decrease in length as under

$$\text{PLCR \% (linear)} = \frac{\text{Increase/decrease in length}}{\text{original length}} \times 100$$

Volumetric change:- The PLCR can also be expressed as percentage of increase/decrease in volume as under

$$\text{PLCR \% (volume)} = \frac{\text{Increase/decrease in volume}}{\text{original volume}} \times 100$$

Procedure to determine PLCR

- i. Cut the test specimen of size 5×5×12.5 cm by cutting wheel. In case of smaller refractory shapes, the specimen of largest possible size is cut. Retain maximum possible original faces.
- ii. Determine its volume and Place it in kiln having oxidising atmosphere. Keep the specimen in such a way that flame does not impinge directly on specimen. The largest face of the specimen should rest on a supporting refractory brick drawn from same lot of refractories that are under test.
- iii. Place fused alumina or kyanite of – 85 micron I.S. sieve between supporting refractory and test specimen. Keep the specimens 4cm apart.
- iv. Heat the test specimen according to set time-temperature schedule of particular refractory.
- v. Hold the refractory for given time at maximum temperature as per stipulated time.
- vi. Cool the refractory specimen in the kiln itself in 10 hours.
- vii. Measure its dimensions again and calculate its volume.

ix Calculate PLCR by using following formula:-

$$\text{PLCR \% (linear)} = \frac{\text{Final length} - \text{original length}}{\text{original length}} \times 100$$

$$\text{PLCR \% (volume)} = \frac{\text{Final volume} - \text{original volume}}{\text{Original volume}} \times 100$$

2.5.12.2 Dialtometer method of testing PLC:-

This method is used to measure linear change of refractory sample with temperature.

Dialtometer assembly is shown in figure 5.11

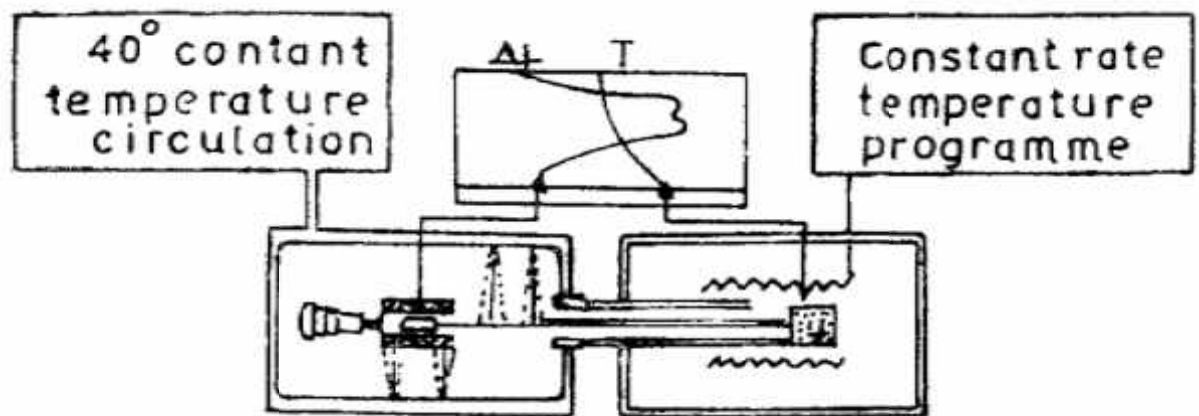

Figure 5.11 Dialtometer Assembly

In this test a sample is cut in shape of cylinder or bar. Clean the sample from any loose dust particles. Place the cut specimens on supporting tube in such a way that its other end is free to expand. This free end is joined to core of an electronic displacement transducer. When sample is heated change in length takes place. This makes the free end to move and which in turn pushes the ceramic rod. This rod pushes the core of the transducer. Record the deflection in millivolt. This deflection is proportional to the change in length of specimen. Time to time standardisation of dialtometer is done with the help of material of known coefficient of thermal expansion. From this correction factor is determined for expansion which takes place in ceramic tube and carrier

refractory on heating along with specimen. Dilatometric analysis enables you to determine structural changes and percentage of different phases formed due to transformation on heating. These changes involve changes in volume e.g. % of cristobalite, tridymite and quartz in a silica brick on heating to desired temperature.

2.5.12 Expansion characteristics:-

Expansion characteristics is very important property for the refractories. It is very essential to know about refractories whether it will expand or contract during heating ensures the stability of it.

Expanding refractories are not suitable for the most applications. Expansion sets up stress causing blowing and bursting of lining. Firebrick, chrome magnesite, forsterite, magnesite and alumino silicate refractories shrink in service. Silica refractories expand on heating due to critical transformation. Expansion of refractories depends on composition and temperature. Expansion of refractory also varies from batch to batch and brick to brick. Ordinary or thermal expansion value is very important in furnace design. This helps for providing expansion joints. Expansion factor also determines thermal shock resistance.

Firebricks have low and uniform expansion up to 1000 °C. The expansion is 0.5% or less. Silica bricks behave differently. Tridymite shows two irregularities, while cristobalite and quartz show one irregularity in thermal expansion as shown in following figure.

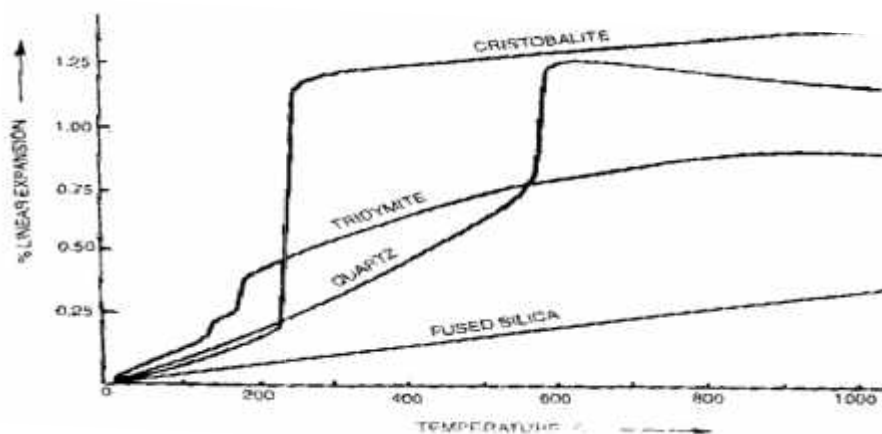

Figure 5.12: Expansion of silica minerals

The thermal expansion of magnesite refractory is comparatively high 1.3-1.4% where as that of chrome or chrome magnesite brick is much lower except in reducing atmosphere. Normal fireclay refractories have low thermal expansion of the order of 0.5% up to 1000 . Reversible thermal expansion of some refractories is shown in following figure 5.13

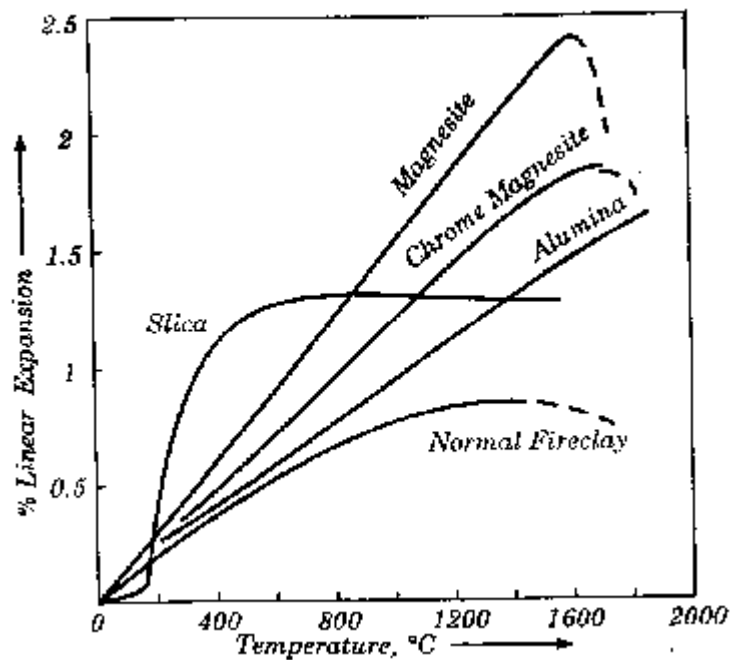

Figure 5.13: Expansion Curve of some refractories

2.5.13 Thermal conductivity test:-

Thermal conductivity depends on chemical and mineralogical composition, glassy phase and application temperature. It does not affect performance but its value determines the thickness of lining. Can you guess what should be its value high or low? Well it depends on application. In some application its value should be high e.g. in recuperators, regenerators, muffles etc, where heat transfer is required. However where heat conservation is required its value should be low. Thermal conductivity can be determined by calorimetric method developed by CGCRI Calcutta as shown in following figure 5.14.

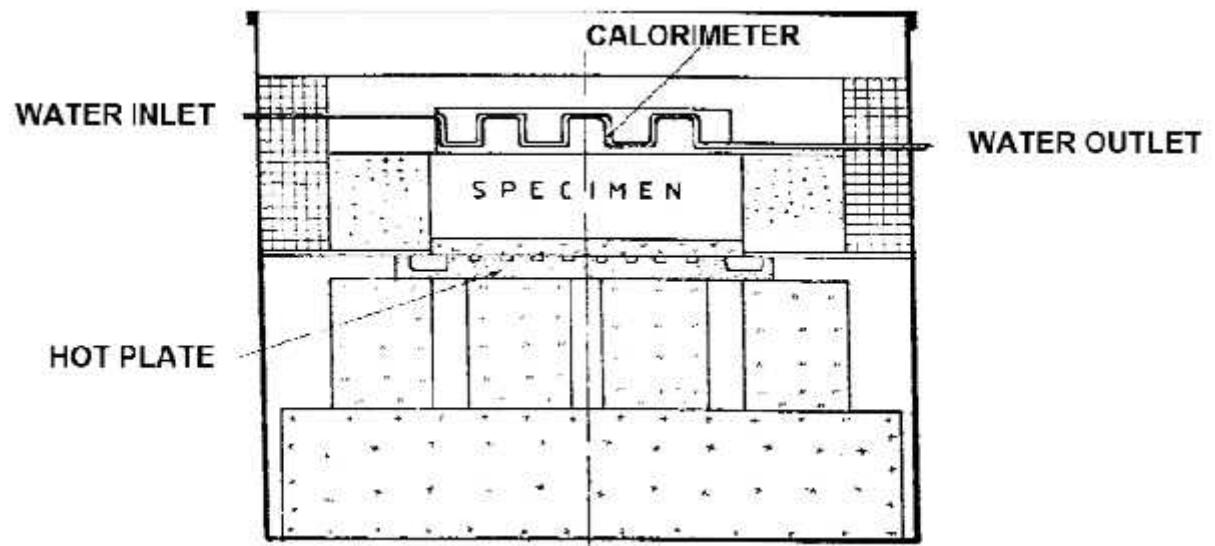
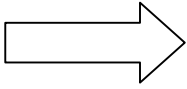

Figure 5.14 Thermal conductivity apparatus

This method was developed by C.G.C.R.I. Calcutta. This method is very useful for measurement of conductivity at very low temperature. This method was specifically useful for measurement of thermal conductivity of cold face (low temperature) low insulation bricks. In this method one end of brick is heated with the help of hot plate. At the other end water is circulated through calorimeter. The inlet and outlet temperature is measured. This gives the rate of heat transfer passing through brick. The water flow is so adjusted such that the temperature of cold end is constant.



Now do the following practice task

1. Define the apparent porosity.
2. Write the formula used to calculate bulk density.
3. Explain determination of MOR.
4. Name the testing method used to find density and porosity of irregular shapes
5. Explain determination of the bulk density
- 6 Name the test used to measure PLCR.
7. Write the formula used to calculate permeability of refractory sample.

NOW CHECK YOUR RESPONSE

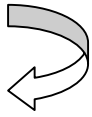

FEEDBACK TO THE PRACTICE TASK

1. Apparent porosity is expressed as percentage of open pore space to the total refractory volume.
2. Bulk Density = $\frac{D}{W-S} \times 100$

where

- D = the constant weight of the Dry Sample
- S = the weight of specimen suspended in water
- W = the weight of specimen in air including the moisture in open pores.

3. Failure of refractory brick generally takes place due to bending moments. MOR test is used to determine resistance offered by brick to bending moments. This test is performed with the help of standard mechanical or hydraulic compression machine. To perform this test cut the test specimen of size 22cm×11.3 cm×6.5cm or 7.5cm. The specimen is cut from desired refractory shape. Place the specimen on the bearing edges of the machine. These edges are positioned 18 cm apart. Apply the load at the middle of the specimen uniformly. The rate should be 10kgf per minute(±10%) in case of mechanical pressing machine. Load should be applied without any jerk. Note the load (W) at which the specimen fails. Then use following relation to calculate MOR.

$$\text{M.O.R.} = \frac{3WL}{2bt^2} \text{ kgf/sq. cm}$$

Where L = the distance between bearing edges(cm)

b= width of specimen(cm)

t= thickness of specimen(cm)

4. Boiling point Method and evacuation method.
5. Bulk density can be measured by

(a) Direct measurement method:-

This method is used to determine the bulk density of regular shape refractories. First determine the volume of refractories by measuring its dimensions directly. Then

take its eight. The bulk density is then determined from the formula:-

$$D_B = \frac{W}{V} \text{ (g/cc)}$$

Where w = weight of specimen in grams

v = volume of specimen in cc.

(b) Direct volume measurement method:-

This method is used to determine the bulk density of those refractories which are having intricate shapes. In this method value of dry weight(D), suspended weight(S) and saturated weight is determined. The same procedure is used, which was used for apparent porosity determination. Then calculate the bulk density by using the following formula:-

$$D_B = \frac{D}{W-S} \text{ (g/cc)}$$

Where D = Dry weight of sample(in gram)

$w-s$ = external volume of specimen(in cc)

6. Dialtometer test

7. Permeability = $\frac{V.H.}{A.t.p}$

Where V = volume of air passed through specimen (cc)

H = thickness of specimen(cm)

A = cross sectional area of the specimen(sq. cm)

t = time for which air is passed through specimen(min.)

p = pressure difference across the two surfaces of the sample(g/sq.cm)